

Module 8

Surveying and Setting Out

Contents:	page
8.1 Selecting the Road Alignment	1
8.2 Instruments and Surveying Aids	10
8.3 Setting Out Horizontal Alignment	20
8.4 Setting Out Vertical Alignment	25
8.5 Setting Out Cross Sections	30
8.6 Hairpin Bends	36
8.7 Setting Out Tasks	39
8.8 Recording the Work Programme	40

8.1 Selecting the Road Alignment

8.1.1 Survey

When constructing a new road, there are several possible choices of alignments. Although the shortest connection between two points is a straight line, the road alignment will very seldom be entirely straight. for various reasons:

- (a) a straight and short alignment may cross through villages, farms or other public or private property. In most cases, this is not acceptable as it would destroy crops, buildings or public facilities;
- (b) in rolling, hilly or mountainous terrain, the gradients on a straight alignment would often be too steep or the earthworks required excessive;
- (c) the straight alignment may pass through extremely difficult terrain (rocks, dense forest, swamps, etc.) which should be avoided to minimize construction costs;

Check List

- T Locate the best sites for river crossings.
- T Avoid rocky areas.
- T Avoid areas with heavy bush-clearing.
- T Try to avoid complicated drainage solutions.
- T Try to follow existing alignments of roads and tracks.
- T Avoid steep gradients (maximum 10%).
- T Keep earth-moving at a minimum.
- T Be considerate with existing farming activities in the area.
- T Avoid triggering soil erosion.

- (d) if a river or other obstacle has to be crossed, another alignment may be necessary in order to find a crossing at the most suitable location;
- (e) by choosing a slightly longer alignment, the road can be constructed on a soil type more suitable for road construction.

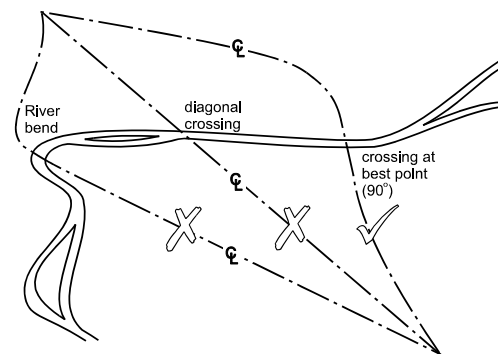

In addition, the choice of alignment may be influenced by the location of suitable sources of water and the location of gravel deposits.

When rural roads are built to provide access, existing tracks should be followed whenever possible to minimize earthworks.

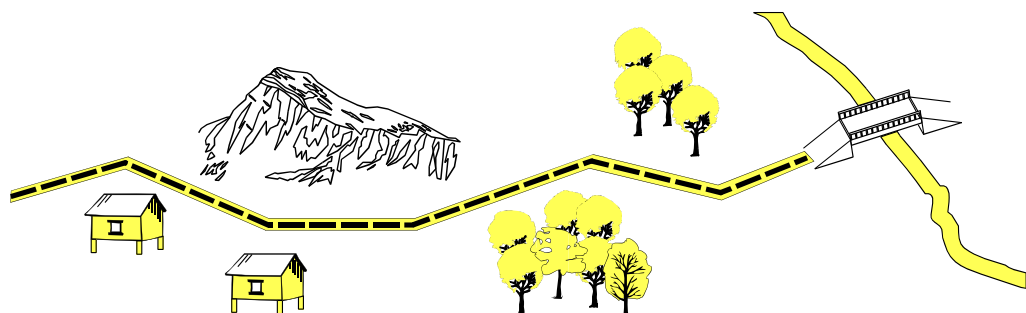

It is also sensible to first make sure that all interested parties agree on the route and places to be linked by a new or rehabilitated road.

8.1.2 Factors Affecting Choice of Route

Where several alignments are possible, the engineer will decide on the detailed design after considering:

- (a) Construction costs - e.g. an alignment of a certain length with steep gradients up to 20 percent (Alignment 1) will be cheaper to construct than an alignment of the same length with gradients up to 5 percent (Alignment 2). For the latter, the necessary earthworks will be far more extensive. Try to avoid steep side long ground even if the existing road is cut into it. Although it is possible to overcome the problem, any solution is expensive in terms of labour, materials and finance. Route selection is therefore important. If possible, relocate the line lower down the hill side where the ground is flatter.
- (b) Costs to future traffic - these costs will be greater for Alignment 1 than for Alignment 2. More energy is used to climb/descend steep gradients and will cause more wear to brakes. Stronger means of transport will be required for Alignment 1. For village roads, it is to assume that these may become market roads as the country develops. Steep gradients should therefore be avoided.

- (c) Maintenance costs - the costs to maintain steep gradients are considerably higher than the costs to maintain gentle gradients.
- (d) Social costs and benefits - in many cases, the higher construction costs of a longer alignment may be justified if the road also serves a public facilities (e.g. school, health centre).

The engineer also has to consider existing land use and to whom the land belongs. Although compensation arrangements would normally be made, careful consideration of all possible alternatives at the design stage may avoid such issues.

- (e) Watershed route - normally cross drainage is expensive but can be avoided if the road follows the line of the watershed. Ditching may then be unnecessary and considerable cost savings will derive. It is therefore advantageous, where possible, to locate and use the watershed route.

8.1.3 The Initial Survey

It is important to set out the centre line of a new road well in advance of the start of the construction works. This will allow the local people to resolve any right-of-way problems and to ensure that no new crops are planted in the road area.

The initial survey will be an essential component of the cost calculation and budget allocation. From the survey, quantities of work can be derived, soil conditions observed and productivity norms assumed. The line as established by the surveyor must be clearly defined to facilitate construction.

It is important to stress, however, that during the survey the subsequent end product must be borne in mind. For a new road to be built by labour-based methods and likely to carry low traffic volumes, the alignment selected should reflect this. A high speed alignment is irrelevant and expensive. Undulating vertical curvature and comparatively sharp curves are more compatible with low volume roads. The objective of such a survey is to refine actual position and dimensions of the road. The survey and methods used should be simplified without prejudicing the level of accuracy desired.

8.1.4 Supplementary Survey

Often, immediately preceding road construction, a supplementary survey is undertaken. The purpose may be to investigate a better line or cheaper route. But more frequently, it comprises pegging out the route, and establishing the width and level of the road. Salient points should be staked to normally form the basis of any recalculation of quantities, the basis for measurement of work undertaken and assessment of performance of the work force.

8.2 Instruments and Surveying Aids

There are a number of appropriate methods for setting out the road alignment. The surveying equipment required is based on the setting out methods chosen. When choosing a specific method of surveying, it is important to bear in mind the required level of accuracy for the works. Obviously, the requirements of a rural road may not be the same as for major highways or city streets. Bearing this in mind, the following section describes some low-cost but still accurate enough methods of setting out rural road alignments.

8.2.1 Types of Survey Equipment and Use

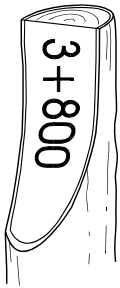

Reference pegs are used to mark the alignment and road levels. They are invariably of wood, tree branches or stakes cut to length, ideally 40 cm long and 5 cm diameter or 5 cm x 5 cm square. It is advisable to paint them white or yellow for visibility and paint the chainage on a prepared face. To avoid loss or damage, the pegs should be offset from the road width, hammered deep into the ground to avoid pilferage and placed in a prominent location.

Survey pegs are usually set on the centre line, but unless there are no earthworks to be undertaken, they should be off-set from the road width. Multipurpose pegs may be needed to stake out cross-section, tasks, levels, etc. They are normally sharpened sticks 30 cm long used in conjunction with a string line to define horizontal or vertical alignment.

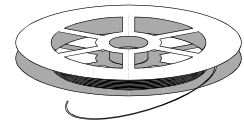

Tape measures are made of steel or linen, the most useful length is 20 or 30 meters. Steel is expensive, liable to damage and illegibility after a period of use. It is recommended that the linen tape are used although they are not quite as accurate as steel. Tapes are vital for length and width setting out as well as setting tasks or defining contract limits.

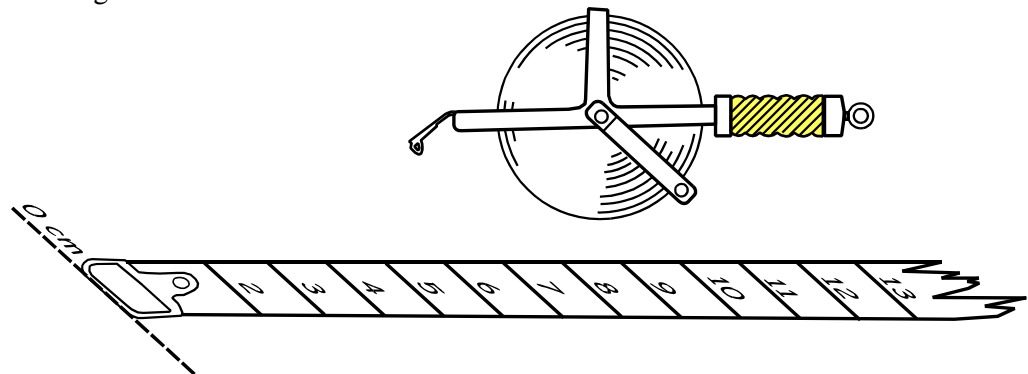

Smaller tapes, 2m, 3m or 5m in length, are useful for small construction elements, such as profiles of ditches, raising cambers, etc.

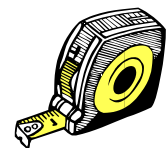

Profile Boards and Ranging Rods are useful for setting out levels. Also, the ranging rods are used for setting out straight lines and curves.

A long lasting profile board is made from thin steel plate which is welded to a short length of metal tubing that can slide up and down and be clamped to a metal ranging rod. A useful size for the metal profile boards has been found to be 40 cm by 10 cm, painted red to make it easy to see.

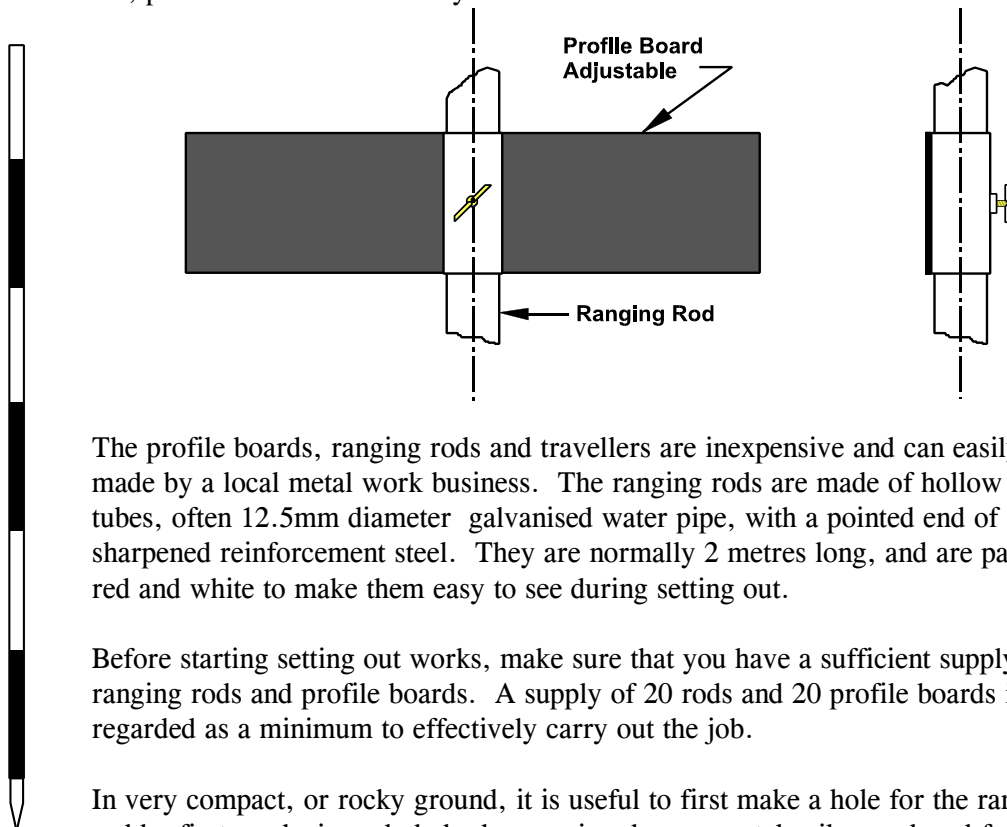

The profile boards, ranging rods and travellers are inexpensive and can easily be made by a local metal work business. The ranging rods are made of hollow metal tubes, often 12.5mm diameter galvanised water pipe, with a pointed end of sharpened reinforcement steel. They are normally 2 metres long, and are painted red and white to make them easy to see during setting out.

Before starting setting out works, make sure that you have a sufficient supply of ranging rods and profile boards. A supply of 20 rods and 20 profile boards is regarded as a minimum to effectively carry out the job.

In very compact, or rocky ground, it is useful to first make a hole for the ranging rod by first producing a hole by hammering down a metal spike produced from high tensile reinforcement steel. Crow bars can also be used for this purpose.

A very useful additional tool is a *sliding hammer* with a weighted head that fits over the ranging rod and can be used to drive the ranging rod into the ground.

Line Level

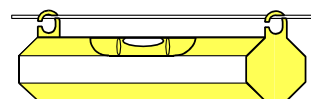

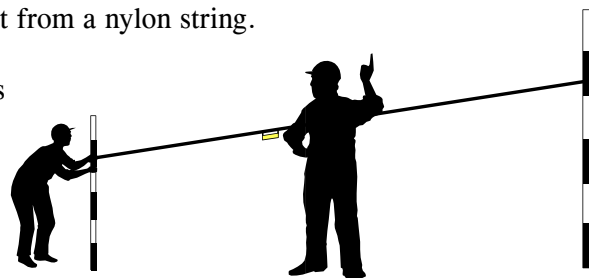

The level of each of the profile boards can be controlled by using a *line level*. The line level is a short spirit level (about 100 mm long) with a hook at each end to hang it from a nylon string.

This instrument needs two persons to operate - one at the end of the line, and the second to watch the spirit level. The line operator moves the string up or down until the bubble is centred in the middle between the



spirit level marks. The string line will then indicate the horizontal line. The line level can be used to:

-  transfer the exact level of one profile board to another profile, thereby ensuring that both are at the same level,
-  measure up or down from a known horizontal level, and set a new level, and
-  find the slope between two fixed profile boards, and determine which one is higher.

The line level has a range of up to about 50 metres. It is easy to carry around and with care can be used for setting out levels and slopes not less than 1 in 300.

Points to remember when using a line level:

- T The string used should be a thin nylon fishing line, enabling the line level to easily slide along the string.
- T The line level must be placed half-way between the two ranging rods. Use a measuring tape to find the exact middle point.
- T Keep the string tight - do not let it sag.
- T The line level is an delicate instrument, look after it - do not throw it around and treat it roughly.
- T Check the accuracy of the line level regularly in the field.



Checking the Line Level

Take two ranging rods across the road and transfer a level from one rod to the other. Mark the level on the second rod.



Then keeping the string in the same position on the first rod, take the line level and turn it around on the string. Adjust the string on the second rod until the bubble is in the middle again and mark the new level.



Check to see if the two marks are at the same place. If not, measure the difference between the two marks.



If the difference between the two marks is less than 10 cm, you can get the right level by taking the point half way between the two marks.



If the difference is greater than 10 cm, you should replace the line level for a new and more accurate one.

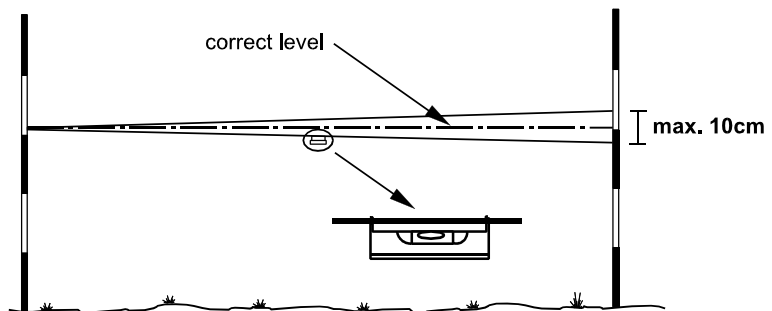

It is always a good idea to turn the line level around every time you use it and take the middle of the two marks as the horizontal level.

Boning rods are generally manufactured on site from wooden laths to a " T " profile and of uniform height. A simple stand can also be manufactured.

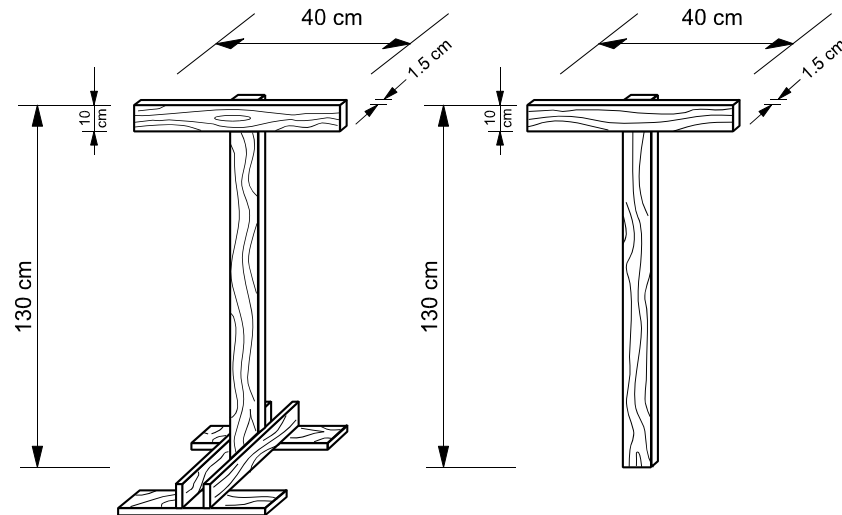

Boning rods are used in sets of 3 and the crosspiece is frequently painted, ideally each with a different colour. They are used to establish additional levels between fixed levels (interpolation) or beyond (extrapolation). They are particularly useful to check gradients of ditches and culverts. In the figure below, it can be seen that the ground level at point 3 is too low and the boning rod is positioned too far to the right. By raising this boning rod and aligning it with rods 1 and 2, the bottom of rod 3 indicates the required level and its location is on a straight line.

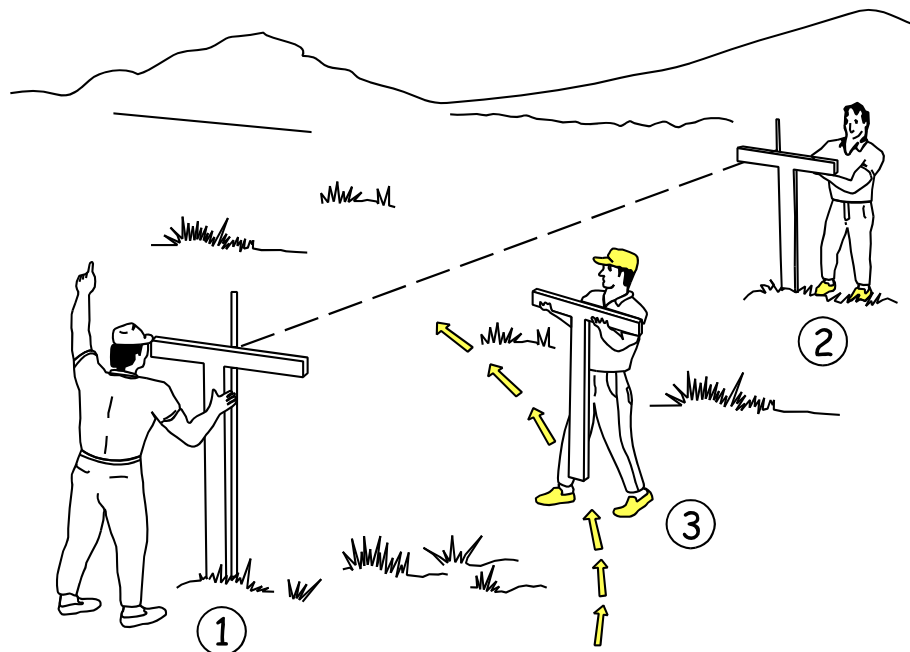

The same exercise can be carried out using profile boards, with the advantage that it would only require two persons to perform the task.

The Profile Board Method

A commonly used setting out procedure is based on the use of a series of profile boards and a string line level giving control of levels during construction. The basic principle when using profile boards is that when they are set out we are placing a series of level boards that show the level 1 metre above the completed construction levels.

Imagine that a ditch is to be excavated from A to B at the level shown in by the dotted line:

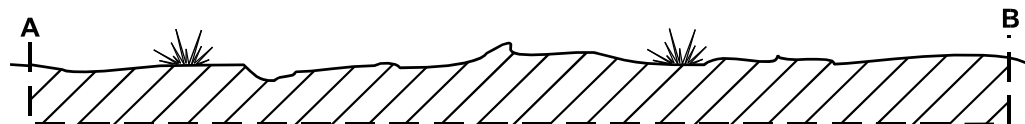

To ensure that the correct level is obtained in the ditch, profile boards are placed at positions A and B, 1 metre above the level of the planned ditch:

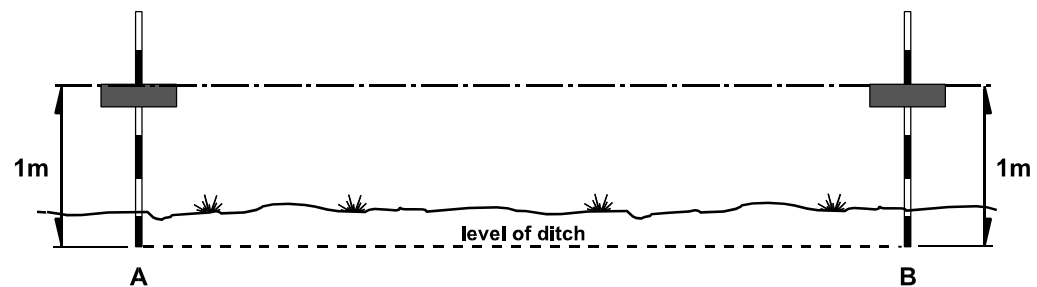

Traveller

A travelling profile is used to obtain levels between two profile boards. A boning rod or a profile can be used as a traveller. Along the line from A to B, slots are excavated to the level of the ditch. By placing the traveller in a slot and sight from the profile board in position A to the profile board in position B, we can see if the traveller lines up with the two fixed profile boards. If the traveller is too low, the slot has been dug too deep. If the traveller sticks up above the sight line, the slot needs to be dug deeper.

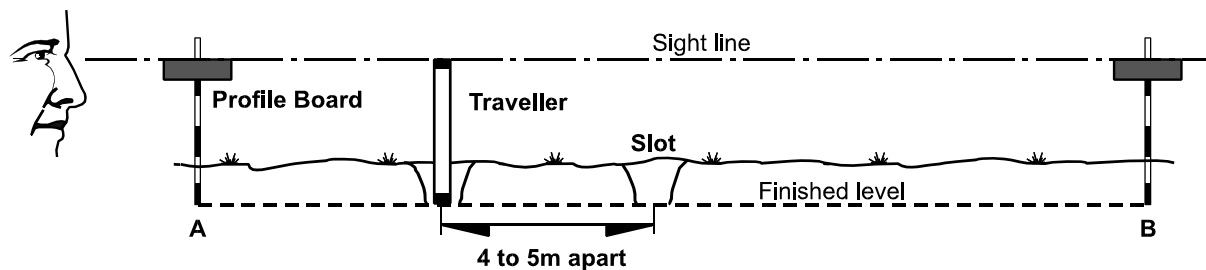

To provide good guidance, slots are dug at regular intervals, say at every 4 to 5 metres along the sight line. When sufficient slots have been dug, the workers can start excavating the ditch by joining up the slots. The traveller can then be used to check that the finished work is to the correct level and that there are no high or low spots.

Temporary travellers

It is also possible to take measurements below the line sighted between two profile boards by using a *temporary traveller*.

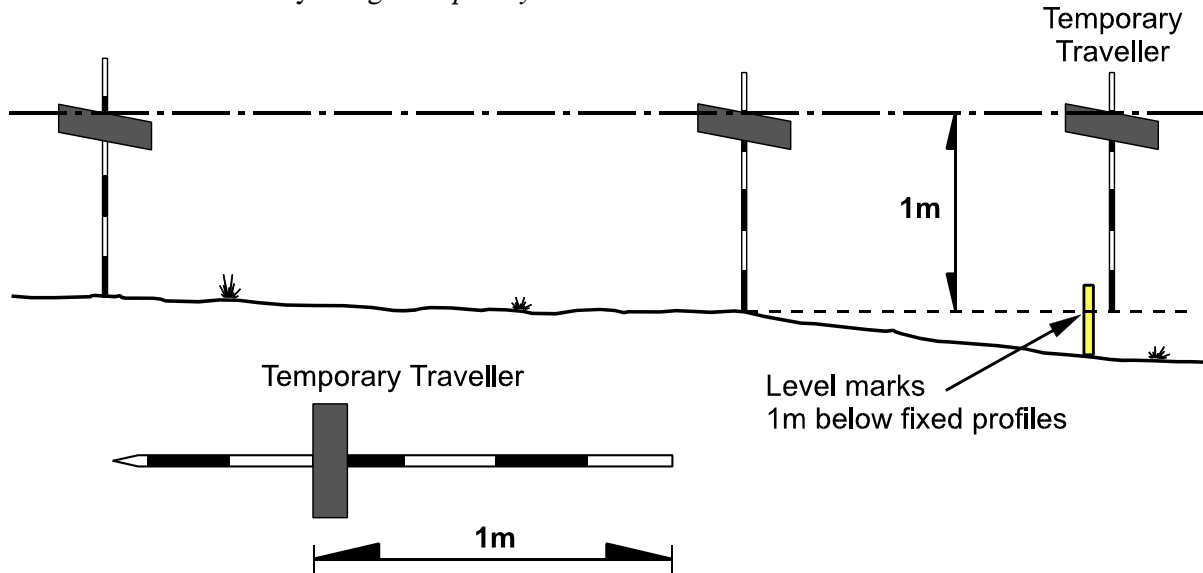

The temporary traveller is easily made on site by measuring the length needed from the blunt end of a ranging rod to the further edge of the profile, which is then clamped in position. The temporary traveller is then ready for use.

When used with fixed set out profiles, the traveller will give an indication of the finished construction levels anywhere along the sight line of the set out profiles.

This is very useful for the site supervisor when setting out. The most frequent use the supervisor will make of temporary travellers, is to mark earthwork levels on the edge of road pegs. But there are other uses for the traveller:

- T to guide and check excavation below earthwork levels (eg. for excavation for drift base construction),
- T to find out whether large boulders are above or below road levels before the road levels are finally decided upon,
- T to estimate the amount of fill needed if the road is "lifted", or when the road crosses low areas - this will help estimate the work involved and help decide on the optimal road levels,
- T to locate the end of drains and approaches, and
- T to provide a quick check on work, levels, string lines etc.

However, for guiding drainage work the labourers and gang leaders should use the specially built travellers or a boning rod. This is because the profile on a temporary traveller can become loose and the supervisor may not be present to check and re-set the traveller length.

Triangles

Triangle sets can be manufactured by the site carpenter from laths and used for various purposes:

- to set out a right angle to the centre line (which has to be done when cross-sections are set out);
- to control or estimate the steepness of gradients - in this case a spirit level or plumb line is also required.

The steepness of gradients is described as a ratio. For example, a gradient of 2 : 1 means two metres horizontal one metre vertical.

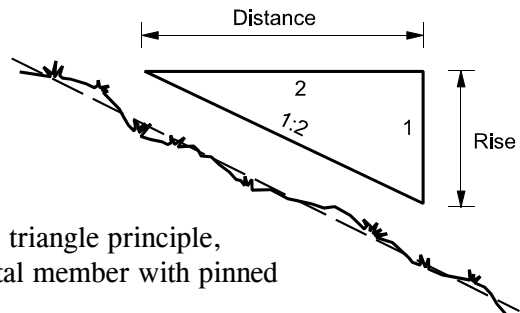

Existing gradients are measured using the triangle principle, incorporating a spirit level as the horizontal member with pinned joints rather than fixed.

The triangle can also be useful in establishing a right angle to the road centre line as illustrated in the figure below.

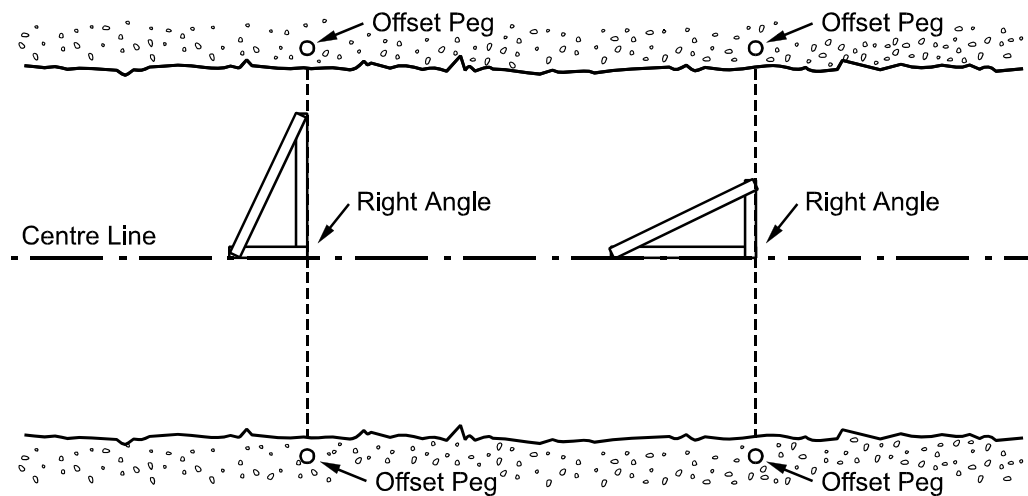

Optical Square is a small instrument using either mirrors or a prism to establish a right angle as illustrated in the figure below.

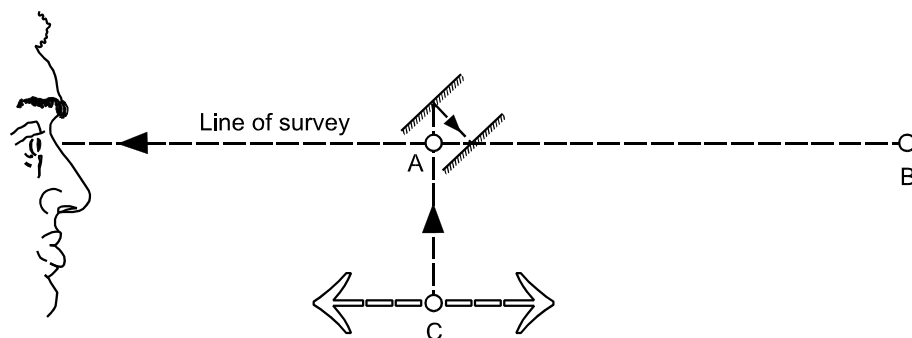

The observer can see both point B, through a narrow opening left in the optical, square and point C in the mirror or prism.

When two ranging rods are placed at points B and C, the observer will see ranging rod B direct and ranging rod C reflected as illustrated in the figure below.

When points A and B on the survey line are known and point C has to be found, as shown in the figure above, the person holding ranging rod C should move forwards or backwards until the observer see the reflection of rod C in one line with his direct view of rod B. At this point angle CAB, is now at a right angle.

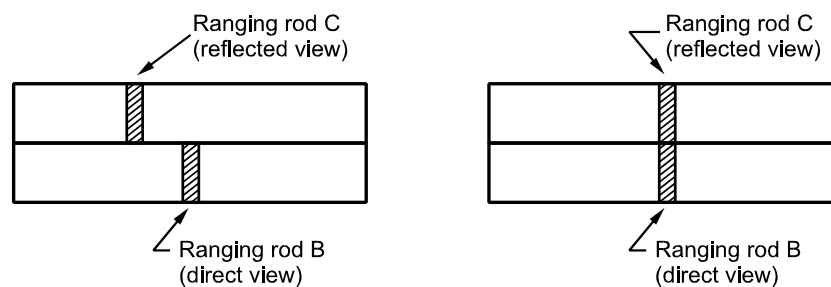

Straight Edge is a simple beam, usually wooden, which in conjunction with a spirit level and tape measure, can be used to establish a gradient/or road camber.

The straight edge is usually 3 metres long and set horizontally with the aid of a spirit level. This method should be used for the measurement of gradients which continue only for short distances, e.g. culvert beds, drain slopes and road camber. The figure below shows how a gradient of 1:15 is measured.

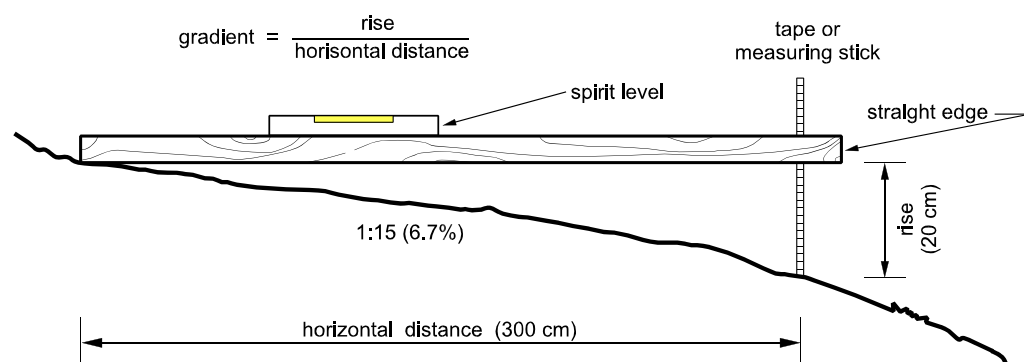

Tube Water Level

A very accurate and simple instrument for measuring the level differences of two points is the "tube water level".

This level, illustrated in the figure below, consists of a length of clear plastic pipe clipped at each end to a wooden levelling staff. The two levelling staffs should be of the same length, about 1.5 m long. A graduated tape is attached to each stave, with the zero level with the top end of the stave. The tube is filled with water until the level is about 1 m high from the ground. The ends of the tube are fitted with rubber stoppers to prevent loss of water. The total length of tube, which defines the range of the instrument, is variable, but is usually limited to about 15 m by the difficulty of moving the level around.

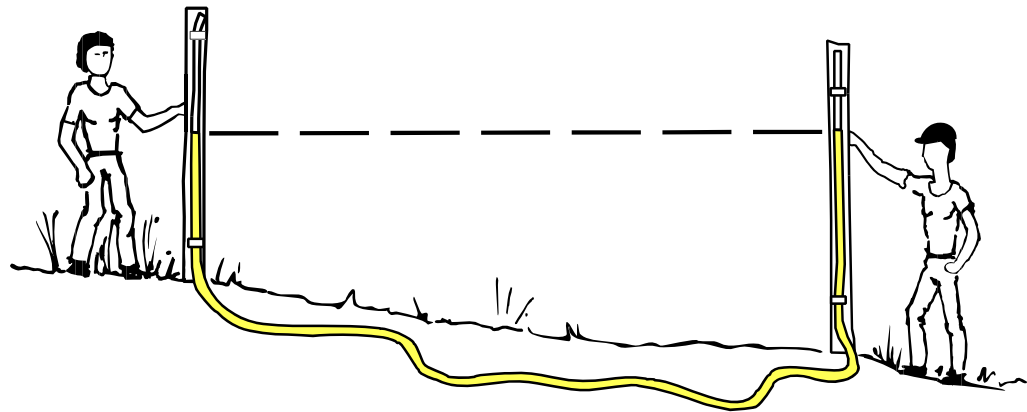

The two standpipes are brought together at the starting point, the stoppers removed and the readings taken level with the bottom of each meniscus. The readings should be the same (e.g. reading A = 50 cm, reading B = 50 cm). The surveyor takes his/her standpipe to the point being measured and takes another reading. The difference between the two readings is the difference in level (e.g. now reading A = 30 cm and reading B = 70 cm, the difference in level is now $70 - 30 = 40$ cm).

Range is limited only by the convenience of being able to carry the tube. The two points whose difference in level is being measured do not need to be in sight of one another. The level gives accurate results and with care can be used for setting level lines or slopes not less than 1 in 1,000.

Abney Level can be used for the measurement of vertical angles for setting out levels.

Vertical angles, are measured as follows:

The sight is taken on to a point which should be at the same height above the ground as the eye of the observer. The line of sight will then be parallel to the ground surface between A and B (see figure below).

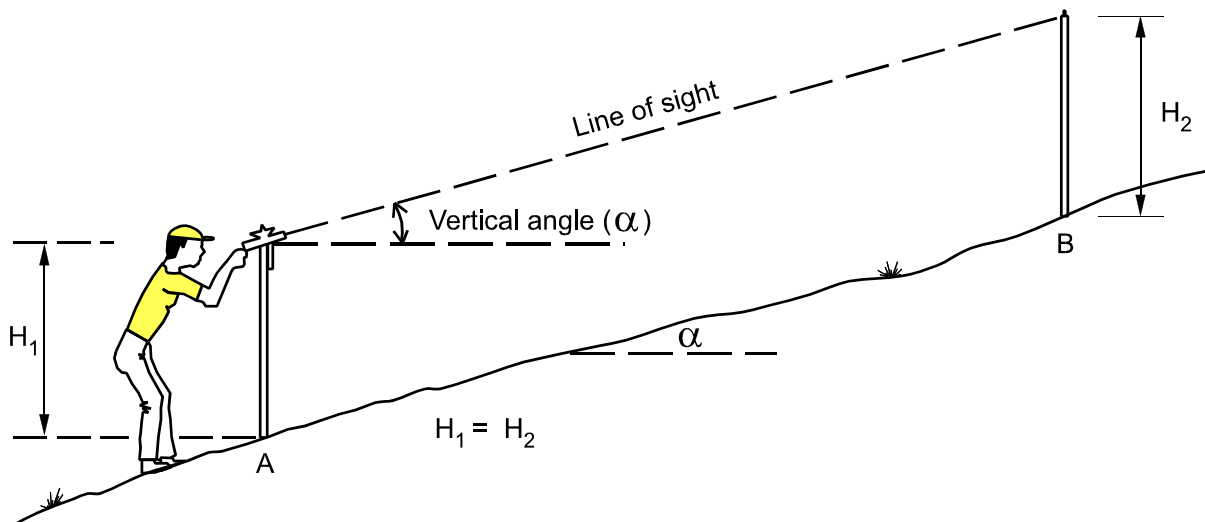

Holding the abney level in this position (the cross hair intersects the target), the air-bubble in the tube of the abney level should be positioned in the middle against the cross hair by turning the milled head. The angle of the line of sight with the horizontal can then be read on the arc.

The abney level can also be used to set out gradients. The arc should be set at the required angle or gradient (e.g. $5^{\circ} 40'$ or 1:10) and a line of sight established to a profile board which is moved up or down until the top of the profile board is at the correct height.

Finally, the abney level can be used to measure distances and to transfer heights. The degree of accuracy that can be achieved, however, is not very high. Where greater accuracy is required it is recommended to use tape measures for distances and levelling instruments for heights.

The **dumpy level** is used to measure height differences used in combination with a levelling staff. Levels can be transferred from a bench mark and new levels can be established very accurately over distances up to 100 meters. There are several types of dumpy levels on the market, each with its own system. It is recommended that engineers or surveyors should practice using the instrument by checking its accuracy before taking it into the field.

A **camber board** can be used to establish the camber of the road. Its length is usually the distance from the centre line to the shoulder of the road. In cases where the shoulders have the same gradient as the running surface, the length of the camber board can also include the shoulder.

The figure below shows a 2.50 meter long camber board showing a gradient of 6 percent (1:20). The length and gradient should be modified to suit the required profile.

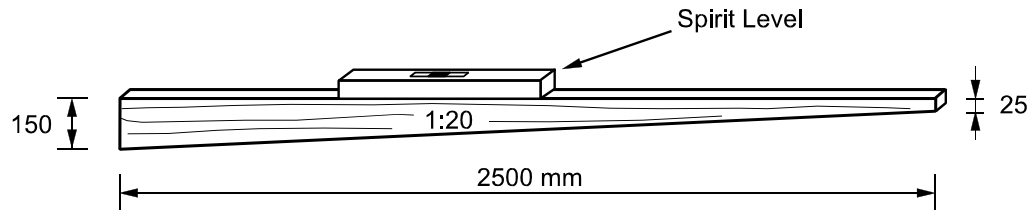

The camber board is used in combination with a spirit level as shown below:

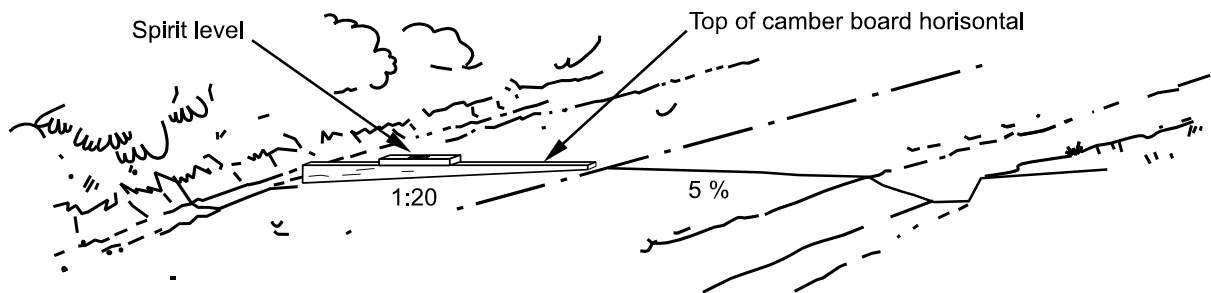

Ditch templates are generally a trapezoid constructed of timber laths or plywood to check the profile of ditches, mitre drains, back slopes, etc.

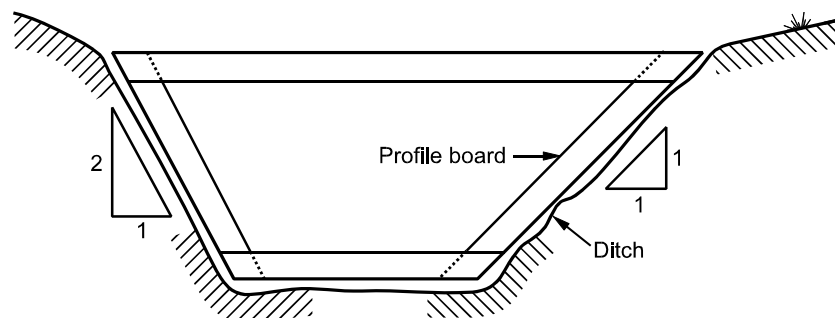

8.3 Setting Out Horizontal Alignments

8.3.1 Responsibility for Setting Out

Prior to construction, it is normal practice for the Surveyor to prepare a detailed centre line survey. This centre line survey should normally consist of stakes located every 20 metres on straights and every 5 to 10 metres along curves. A mark is placed on each of these stakes defining the distance (up or down) to the finished formation level of the road surface.

In order to relieve the surveyor from the onus of providing daily assistance to the site, it is essential that the basic survey skills are available on site.

8.3.2 Setting Out a Straight Line

Straight lines are set out by marking points every 50m to 100m with ranging rods. Between these ranging rods, intermediate points are set out at every 10m. Normally, sections of not more than 50 to 100m are set out at the time. In mountainous terrain, sections of less than 50m may be chosen.

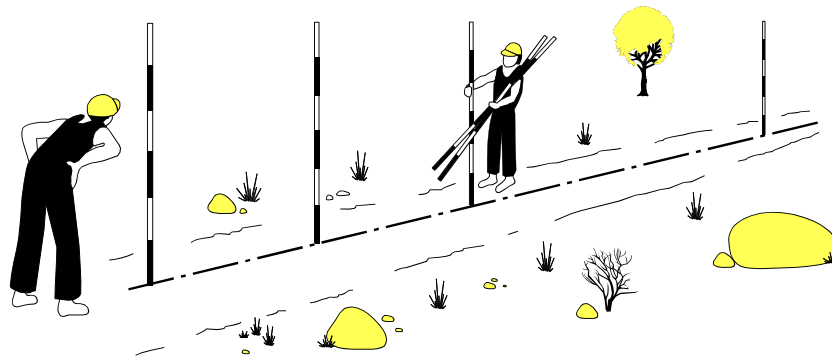

In hilly or rolling terrain, when the line of sight between two fixed points is obscured, the following method can be used to set out the straight.

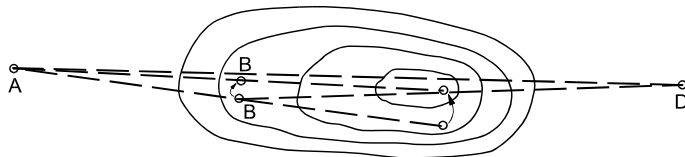

Conditions :

From point A, ranging rods set at points B and C must be visible.
From point D, ranging rods set at points C and B must be visible.

Proceed as follows:

- From A, set B and C in a straight line.
- Sight from D and move C to be in line D-B
- Sight from A and move B to be in line A-C

Repeat this procedure until A-B-C and D-C-B show a straight line without further movements.

8.3.3 Setting Out Curves

The centre line is normally described by means of a series of straight lines meeting at points of intersection. Eventually, these straights will be joined by curves that will be set out during the detailed setting out.

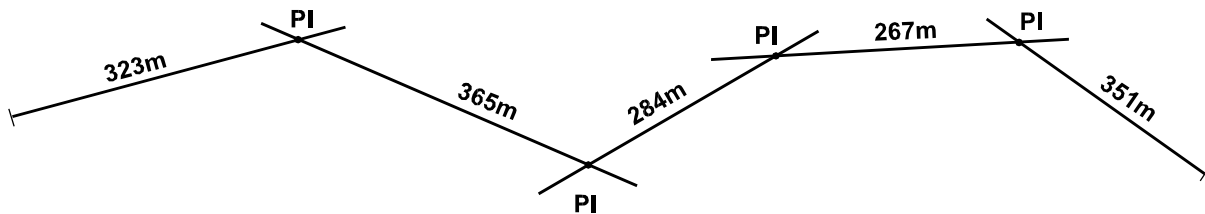

The distance between the intersection points can easily be measured and used as a first estimate of the length of the road to be constructed.

There are various methods to set out curves. With rural roads designed for low traffic volumes, it is usually sufficient to follow existing tracks and to improve existing curves where necessary. Two simple methods to set out circular and parabolic curves using only a tape measure, ranging rods, pegs and strings are described on the following pages.

Curves with a Small Radius

The figure below shows how a circular curve with a 30 meter radius is set out. This method can only be applied when the area around the curve is easily accessible.

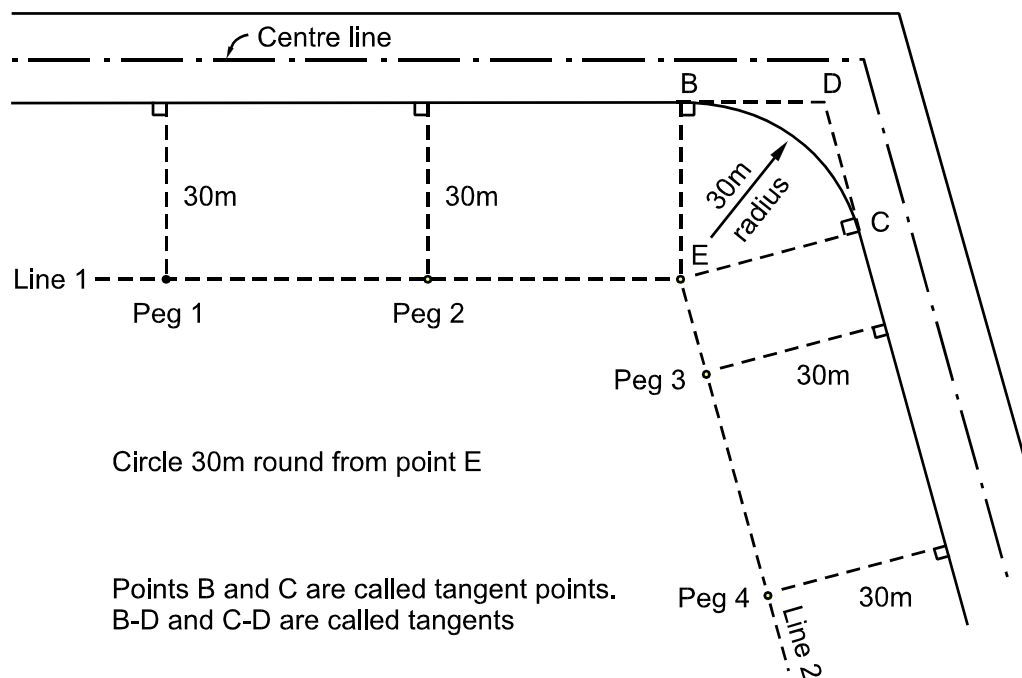

The Intersection Method

The intersection method is a simple and effective method to set out a parabolic curve. It requires simple equipment and can be easily understood by the foremen.

Step 1:



First place a peg at the point where the two straight lines meet (intersection point PI). Then locate the *tangent points*, TP. The first tangent point is where your curve begins, and the second is where it ends. Divide the tangent lines in equal lengths, by setting out a number of ranging rods along the tangent lines, at say 5m intervals.

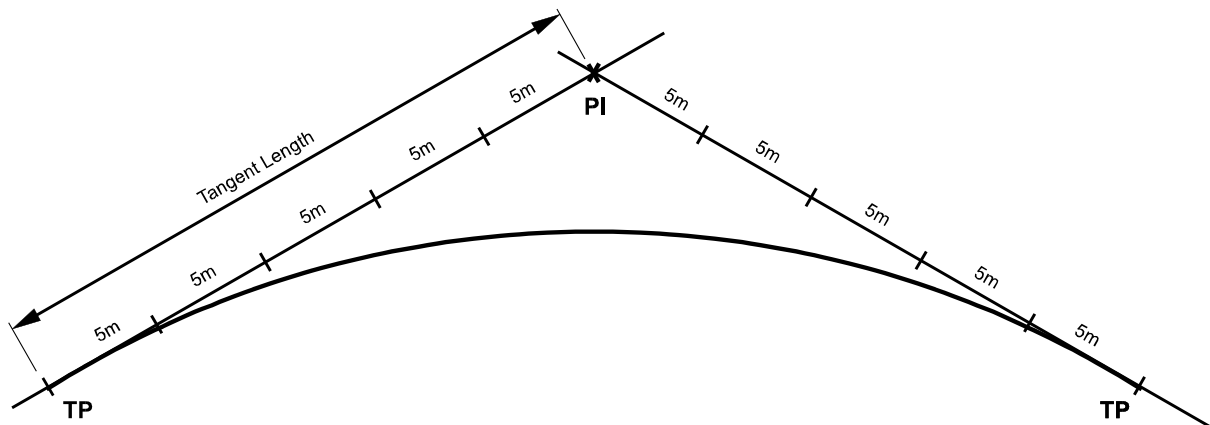

With longer tangents, you will achieve a longer curve with a larger radius. Deciding the length of the tangents is best done by experience. You will gain experience in how to select the best tangent length. First look at the intersection angle between the two tangents:

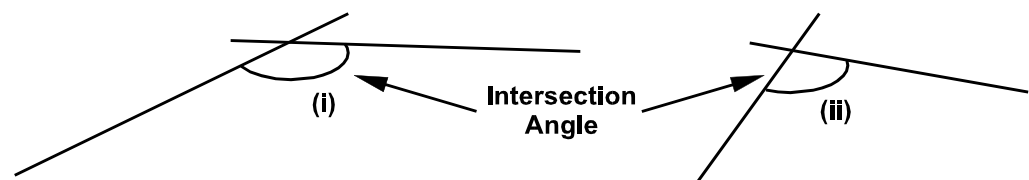

A large intersection angle (i) will produce an easy curve with a large radius. The tangent length can then be short (however, not shorter than 20m).

A smaller intersection angle will give a sharper curve with a short radius. In such situations, the tangent lines should be made longer (30, 40, 50 or 60m) to increase the radius of the curve.

Sometimes, you will want to adjust the tangent length to control where the centre line of the curve goes (see below: Adjusting the Position of the Curve).

Step 2:



Give each ranging rod a letter as shown in the figure below. Sight along line a - a with an assistant holding a ranging rod in your sight line. A second assistant stands at point b and sights along the line b - b. Move your assistant along line a - a until he also stands on line b - b. Mark this spot with a ranging rod and a peg. This is your first point defining the curve.

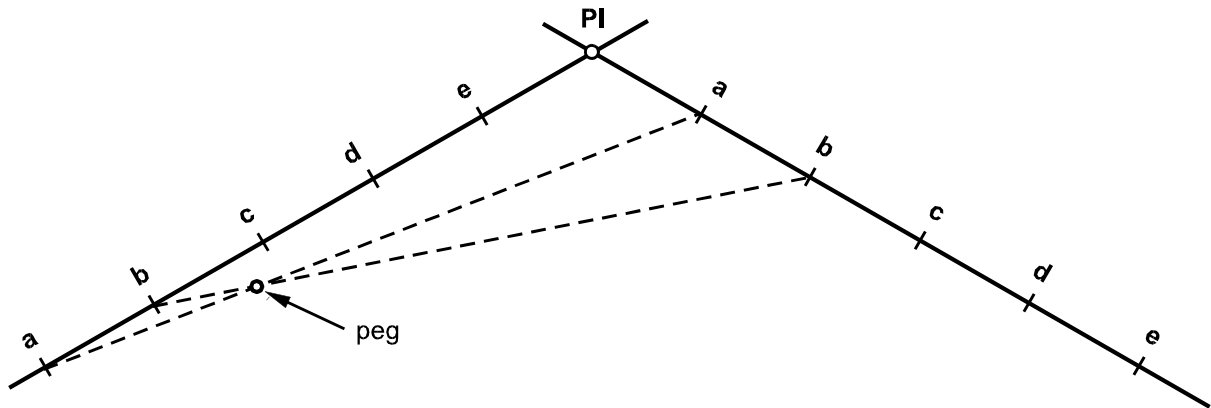

Step 3: Now repeat this exercise by sighting along b - b while an assistant is sighting along c - c to find your next curve point.

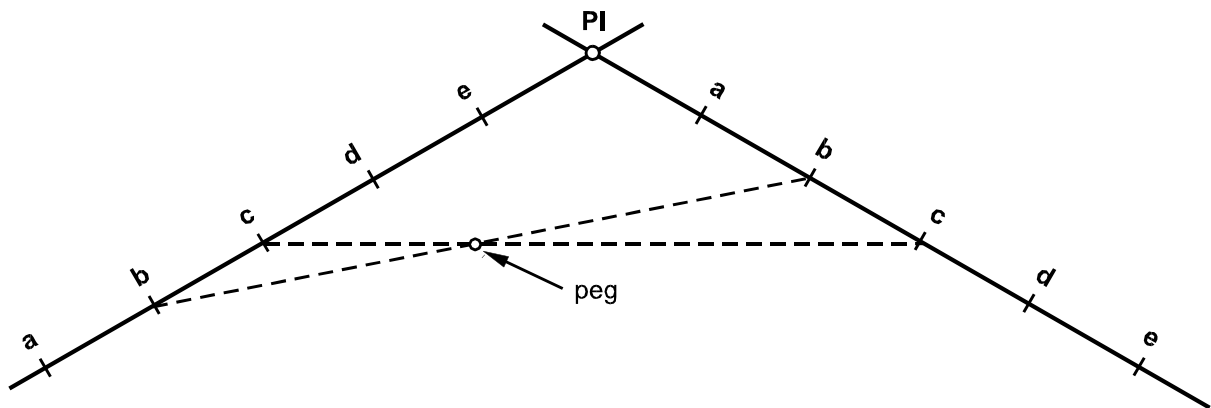

Step 4: Complete the exercise for line c - c, d - d, etc. Finally, use these curve points to set out intermediate points along the curve at 5 m intervals. Inspect the curve and make sure that all the points provide a smooth curve.

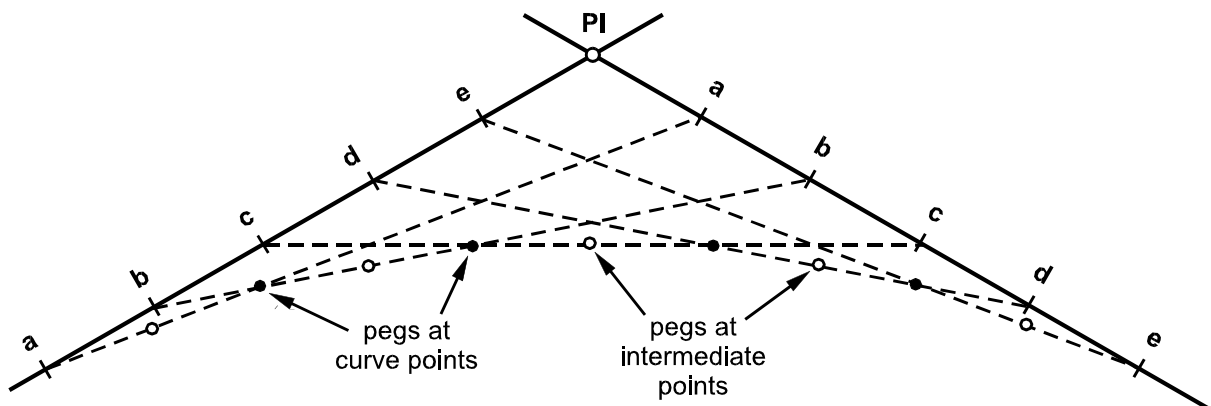

Adjusting the Position of the Curve

You always get one curve point less than the number of ranging rods on the tangent length. For example, 5 ranging rods will give you 4 curve points (as above).

Even numbers of ranging rods gives uneven numbers of curve points, then the middle curve point will be opposite the intersection point, PI. Where the middle two lines intersect is the middle point of the curve (as below with 3-3 & 4-4 and 2-2 & 3-3).

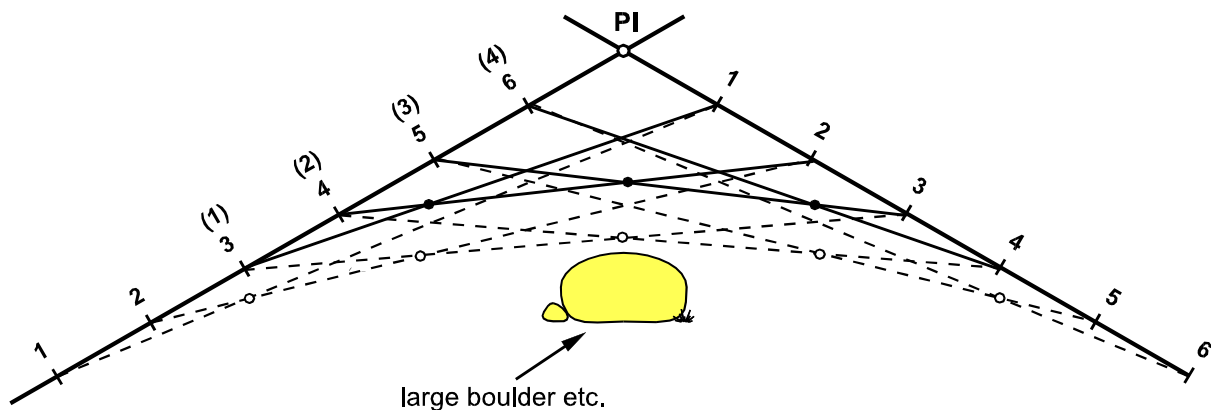

If we increase the length of the tangent lines, the curve moves further away from PI. We can use this when we need to set out the centre line of the curve to avoid obstacles such as trees, buildings, boulders, etc.

8.3.4 Replacement of Pegs

There will often be a need for stakes to be replaced due to carelessness, children playing near the site, theft for fire wood, etc. When the road alignment follows a straight line there is no problem. The missing stakes are replaced by sighting and measuring 20 meters between stakes using those remaining as a reference. If stakes around a curve are missing, this poses a slightly more difficult problem.

However, it is not necessary to wait for a survey as the supervisor should be able to replace curve stakes by using the following method.

Assuming the worst possible case, that is all stakes along the curve are missing, including the tangent-point reference stakes.

It is necessary to know the length of the tangents BD and DC (ref. figure below). These are usually the same, but can be different if necessitated by site conditions. In this case, the curve is not a simple one but a compound of two curves. The tangent length can be calculated from Radius $R \times \text{Tangent } A/2$ where A is the intersection angle in degrees.

A simple way of estimating the intersection angle A is by placing a protractor on the ground at intersection point D and reading the angle. If you cannot find a protractor then use your watch. Five minutes on your watch equals 30 degrees. You only need to be accurate to within 2 or 3 degrees to obtain the required tangent length.

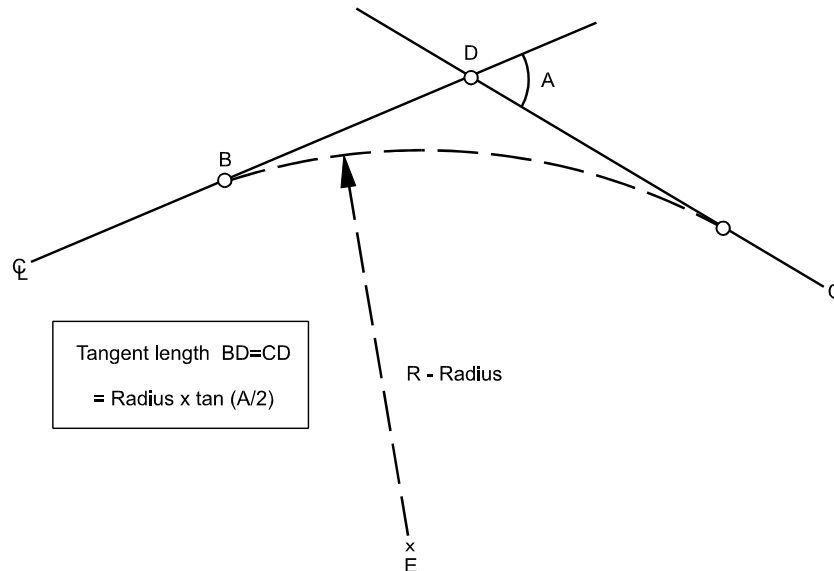

The intersection D can be located simply by sighting back along both tangent lines until the intersection is found. With the tangent length calculated from the above formula, the distance can be measured back in both directions (along the centre line) and the tangent points B and C located and staked. The curve can then be reset by tape measure or as shown in the above figure.

8.3.5 Off-Setting the Centre Line

Once the centre line survey has been established, it is desirable to establish permanent references off-set from the centre line as the centre line pegs may be lost during construction. These off-set pegs become the permanent markers for setting out works, and provides an efficient reference for checking completed works. In other words, these off-set pegs are used for planning, organising and measuring the work.

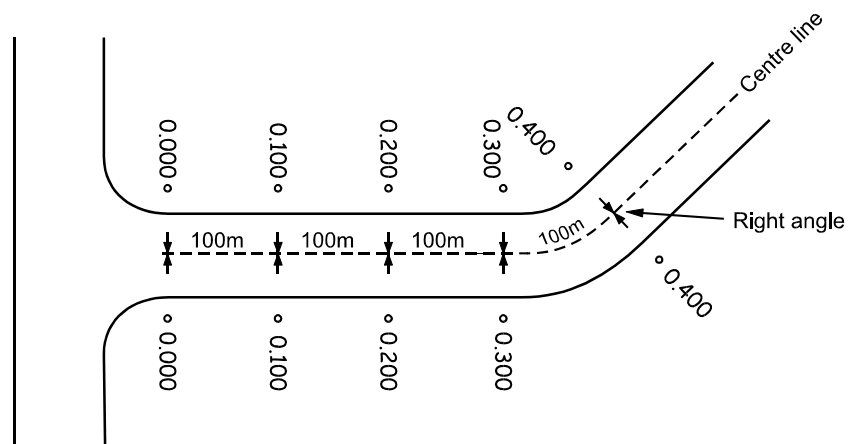

After the road works have been completed, those pegs will be retained to serve as useful references for the maintenance supervisors.

Of crucial importance is that off-set pegs are located at right angles to the design centre line. The following method illustrates a simple way of ensuring this using a piece of string about 5 m long.

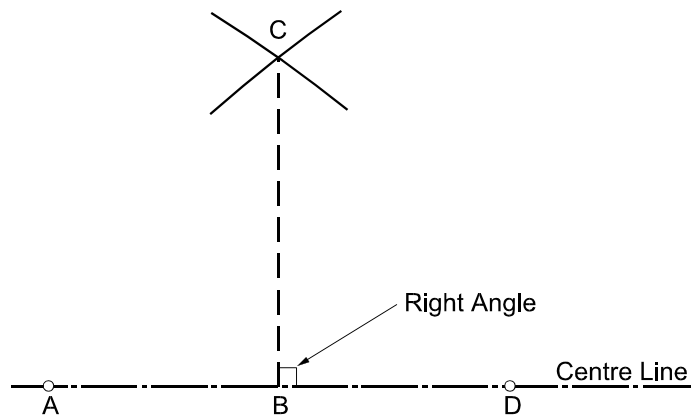

1. Mark the mid-point of the string and layout as shown in the figure, line ABD with B as the midpoint.
2. Drive in pegs at A and D.
3. Using the string, describe an arc from A and D. Point C is the intersection of the two arcs.
4. BC is now a right angle to the centre line.

In flat and rolling terrain, the off-set distance is usually half the width of formation plus the width of the side drains. This would apply to the off-set distance on both sides of the road alignment as shown in the figure below.

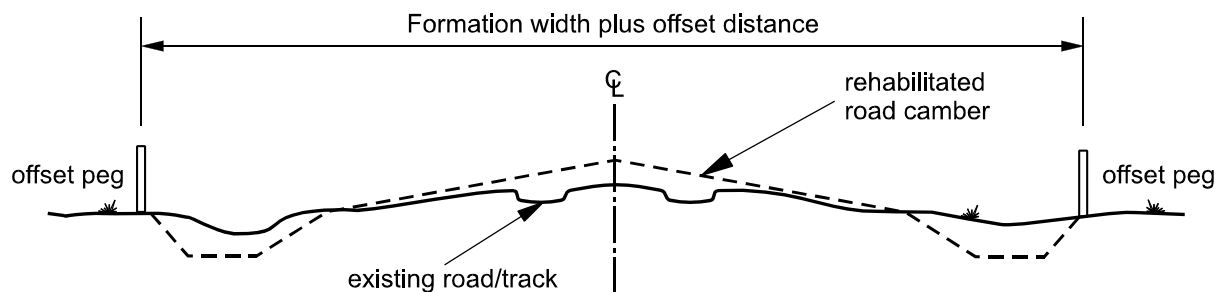

Where the road passes through sloping ground, and side cuts are required, it is necessary to locate a *toe* and a *back-slope* peg in order to fully define the road alignment. Normally, the toe peg defines the outside shoulder edge on the low side and the back-slope peg is that which defines the top of the back slope - the point of incidence between the natural surface and the beginning of the back slope cut.

The location of the toe peg is the distance from the centre line to the outside shoulder edge as defined by the cross-section.

The location of the back-slope peg involves understanding the relationship between cross slope, back slope and formation width of the road. This relationship involves the following calculations:

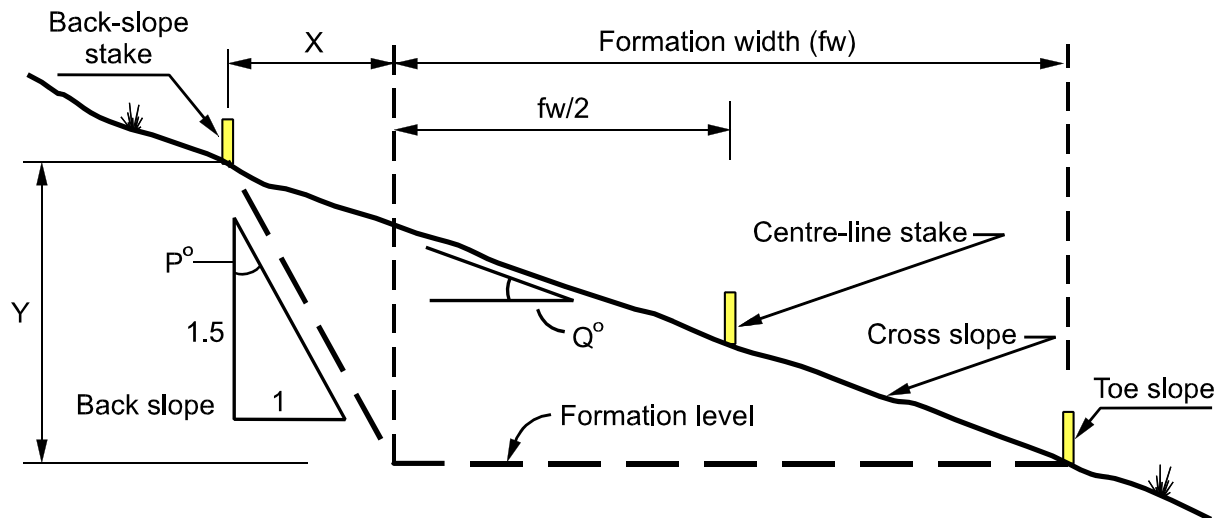

$$\tan Q^\circ = \frac{Y}{X + \frac{fw}{2}} \quad (1)$$

where Q = Cross slope in degrees
 Y = Height to back slope stake from finished formation level
 Fw = Formation width of road
 X = Horizontal distance to back slope stake additional to formation width.

Engineering experience in the Philippines indicate that the back-slope should normally be constructed at 1½:1 for reasons of stability and economy.

If this is the case then a relationship exists between X and Y , i.e.,

$$\tan P^\circ = \frac{1}{1.5} = \frac{Y}{X} \quad (2)$$

Thus (1) and (2) can be combined to determine one unknown, i.e.,

$$\tan Q^\circ = 1.5 \frac{X}{X + \frac{fw}{2}}$$

Here, the only unknown is X , the additional horizontal distance from the centre line peg to the back-slope peg. In other words, the off-set distance, from the centre line peg to the back-slope peg is $\frac{fw}{2} + X$. The distance may be obtained using the straight edge or using two profile boards and a line level as described in Section 8.2.

8.3.6 Off-Set Elevation

Once the off-set pegs have been located in the horizontal plane forming a "plan" of the road alignment on the surface of the ground, the shape of the road in the vertical plane must now be defined by placing levels on the off-set pegs. These levels define the distance down (-) or up (+) from the top of the off-set pegs to finished formation level of the road.

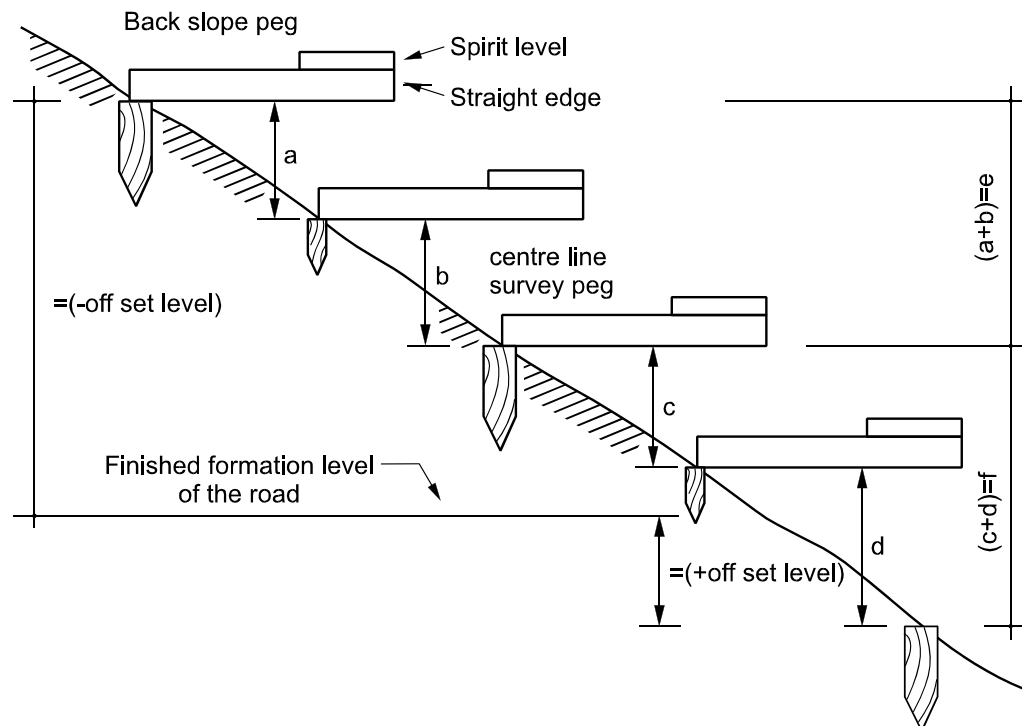

During the initial survey of the road, centre line pegs are located and levelled. Thus on every centre line peg is a level up (+) or down (-) from the top of the peg to the finished formation level of the road. To transfer this centre line peg, level to the off-set pegs, use the straight edge or a line level to determine the cross-slope of the hillside and calculate "X".

From the figure below it can be seen that one end of the beam is placed on top of the centre line peg. The spirit level is used to ensure horizontality of the beam and obtain a measurement to the ground. This process may be continued until the toe off-set is reached. Thus the summation of these measurements will provide the exact excavation and fill levels of the centre line and the toe of the fill.

Equally, the same exercise is carried out to establish the difference between the top of the back-slope and centre line pegs. It is essential that as level differences are measured, a calculation is made using the centre line level data to complete the levels up/down to the finished road formation level from the top of the toe and back-slope pegs. A simple example follows to illustrate these points.

Example:

At chainage 0 + 950, the level on the centre line peg reads (- 0.75) which means that the finished formation level of the road is 75 cm (0.75 meters) below the top of the peg.

Using the straight edge, a spirit level and a tape measure, the difference in levels between the top of the back-slope peg and the top of the centre line peg is found to be 1.35 meters. Using the same method, the difference in level between the top of the centre line peg and the top of the toe peg is found to be 1.05 metres.

Immediately calculations are made as follows;

(a)	Difference in level from top of back-slope to centre line peg is	1.35 m
	Level on centre line peg is	-0.75 m
	Thus level from top of back-slope to finished road formation level is	-2.10 m
(b)	Difference in level from top to centre line peg and toe peg is	1.05 m
	Level on centre line peg is	-0.75 m
	Thus level from top to toe peg to finished road formation level is	+0.30 m

Hint; it is always useful to draw a diagram of these measurement ensure accuracy and immediately write the calculated levels on the off-set pegs.

Thus the off-set pegs now have a full set of information defining:

- (i) the horizontal alignment and
- (ii) the vertical alignment.

8.4 Setting Out the Vertical Alignment

8.4.1 Planning the Vertical Alignment

The vertical alignment or longitudinal section, defines exact level of the road. As with the horizontal alignment, most government departments have standards for how the vertical alignment is designed. Rules concerning the gradients greatly influence the alignment of the road and the amount of earthworks required.

The setting out of the vertical alignment of a road in hilly or mountainous terrain calls for experience. Major earthworks can be avoided if the contours of the terrain are followed. This can often be done in the case of rural roads since the standards for such roads allow for smaller radiuses on the horizontal alignment. Maximum allowable gradients should not be exceeded except in very exceptional circumstances. If possible, the option of alternative horizontal alignment should be explored to avoid steep vertical gradients.

8.4.2 Setting Out

Several methods can be used for setting out the vertical alignment of rural roads in hilly or mountainous terrain. One method is to set out the road using an abney level and boning rods. Another method, described in this section, is by using a string line level and profile boards.

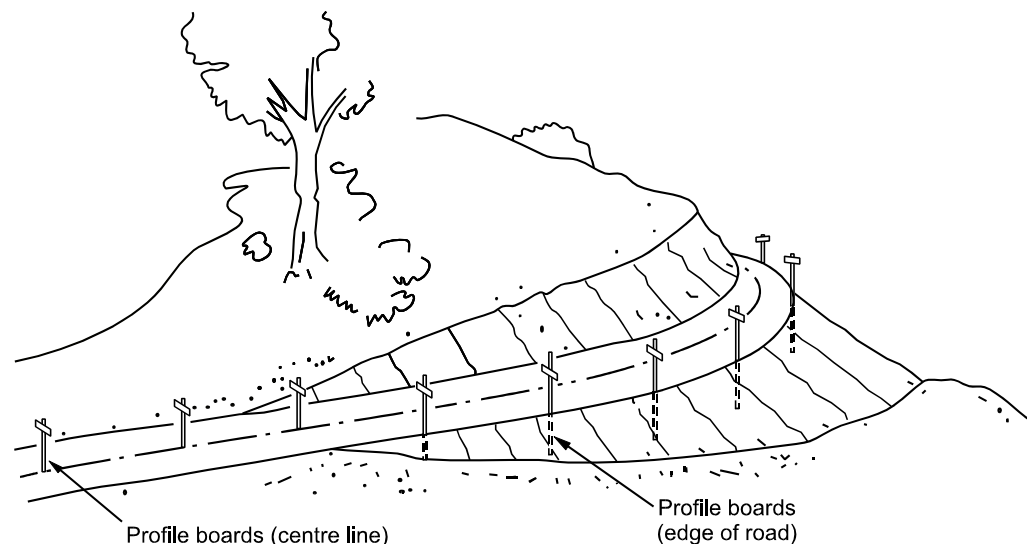

When the horizontal road alignment has been established, the next step is to set out the *vertical alignment*. The vertical alignment sets out the level of the road in relation to the surrounding terrain. The method shown below is based on the use of profile boards to optimise the road level, avoiding unnecessary earth movement.

Step 1: First, fix profile boards on the ranging rods along the centre line at a fixed level, say 1 metre above the ground level.

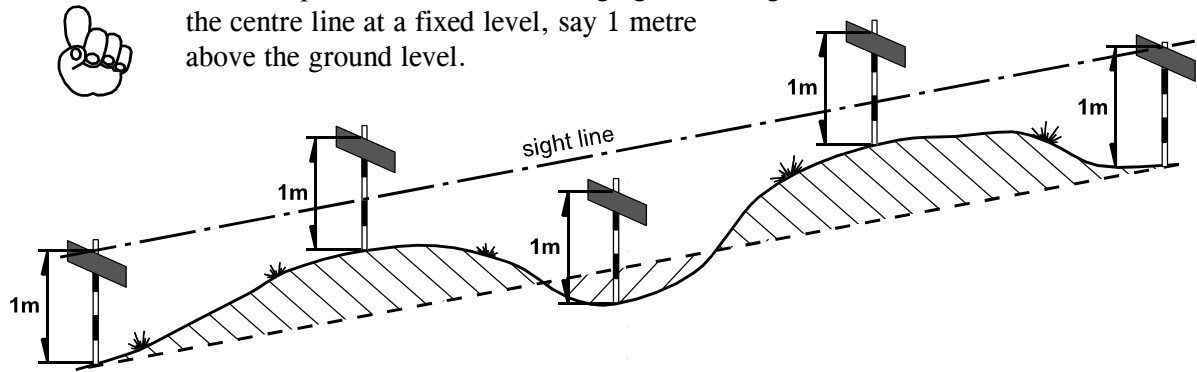

Step 2: Then sight along the profile boards. Get an assistant to adjust the level of each of the intermediate profile boards so they are all on line with the first and the last profile. All the profile boards will then be at a level 1 metre above the level of the centre line of the new road (before designing the camber).

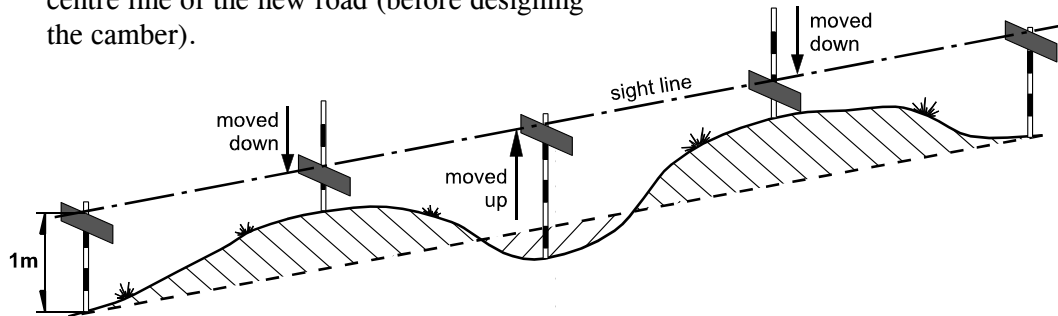

Step 3: If the level of the centre line is too deep into the terrain, i.e. involving too much excavation works, you can move the profile boards up or down to reduce the levelling works, achieving a balance between the volumes of excavation and fill.

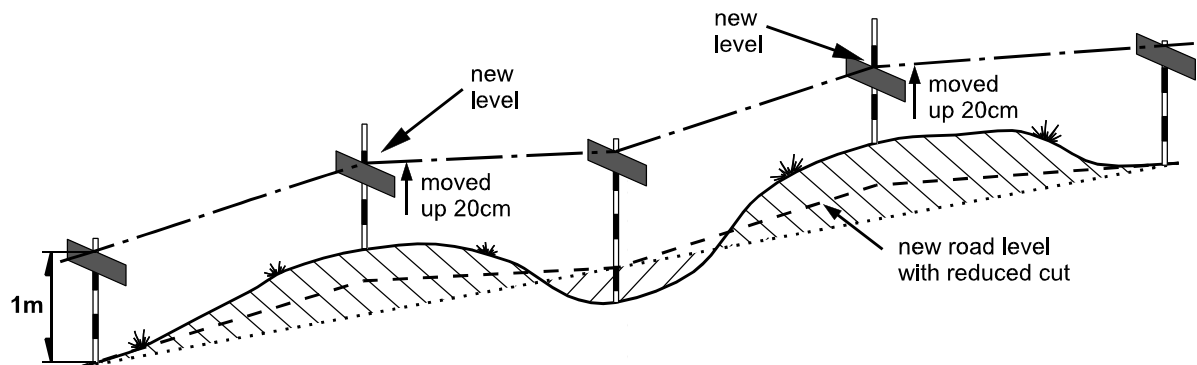

Step 4: Finally, make sure that the profile boards along the centre line has been correctly placed. All other levels for the road structure will be set out based on the profiles along the centre line.

Road Gradients

When setting out the centre line of a road, it is important to check the gradients along the road profiles. Transfer the level of one profile board to the next ranging rod and measure the difference. The slope or the gradient is then calculated as follows:

$$\text{Slope of road} = \frac{\text{level difference}}{\text{length}} \times 100 = \% \text{ slope}$$

$$\frac{0.50}{20} \times 100 = 2.5 \%$$

So, if the difference of levels is measured to 0.5m between two profile boards with a length of 20m between them, the gradient is calculated to:

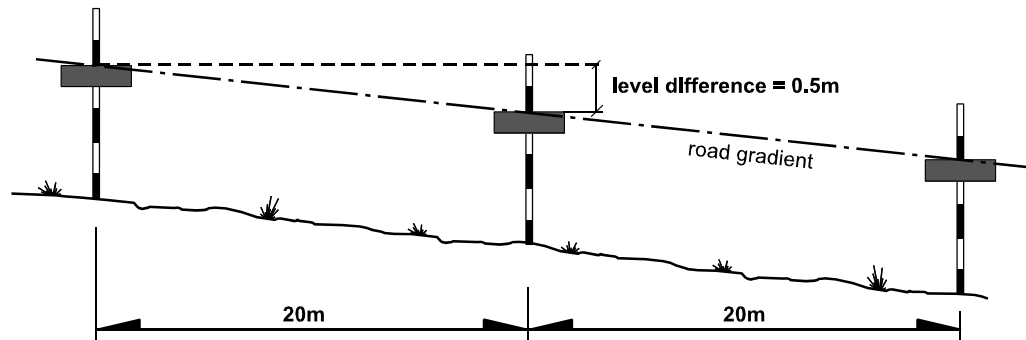

This procedure is very useful in order to find low spots along the road line and to check that the slope of the side drains will not cause erosion or silting. If the road gradient is found to be unsuitable, the road levels can and should be changed before construction works start.

It is also useful, when selecting the road centre line, to check the slope of the existing terrain to make sure it is not too steep or too flat before fixing the location of the centre line.

This is done by setting a profile 1m above the ground at the start of the section in question, and another 1m above the ground on the proposed centre line at the end of the section. A third profile is set 10m from the first profile along the line from the other two.

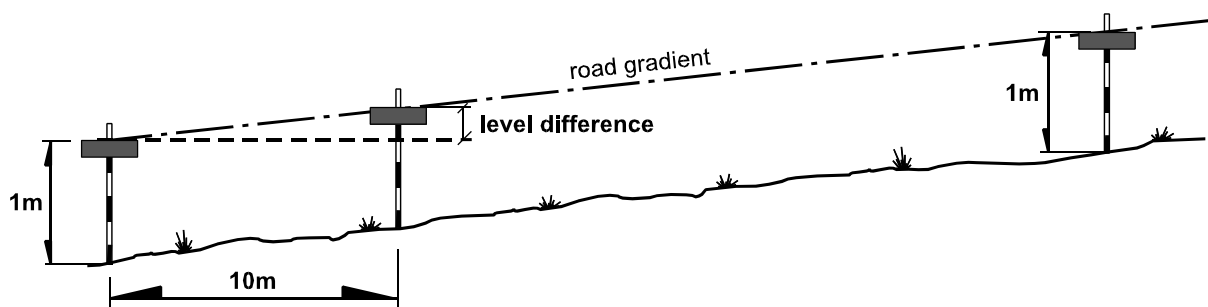

Using a line level, the difference in level between the two profiles 10m apart is measured and the percentage slope of the terrain can be calculated.

$$\text{slope} = \frac{\text{level difference}}{10} \times 100 \%$$

This way, the gradient can be checked before the centre line is fixed, avoiding unsuitable gradients. Try different centre line locations to select the best possible gradient for the road.

8.4.3 Pegging

When the alignment has been determined, it is the task of the supervisor to set the pegs showing excavating limits. It is good practice to place such pegs at a fixed distance (say 1.0 metre) outside the area where the excavation has to take place. To guide the workers, multipurpose pegs can be set at the exact place where excavation has to start. To further guide the workers, these pegs are then connected with strings.

The place where this upper line of pegs will have to be set depends on:

- (i) the width of the road,
- (ii) the angle of the hill side slope, and
- (iii) the angle of the face of the cut.

"Slots" showing (i) the level of the road and (ii) the areas of excavation can be dug into the hill side to facilitate the supervision and the setting of tasks (see hatched areas in the figure below. Slots are discussed in detail in module M-10 "Earthworks".

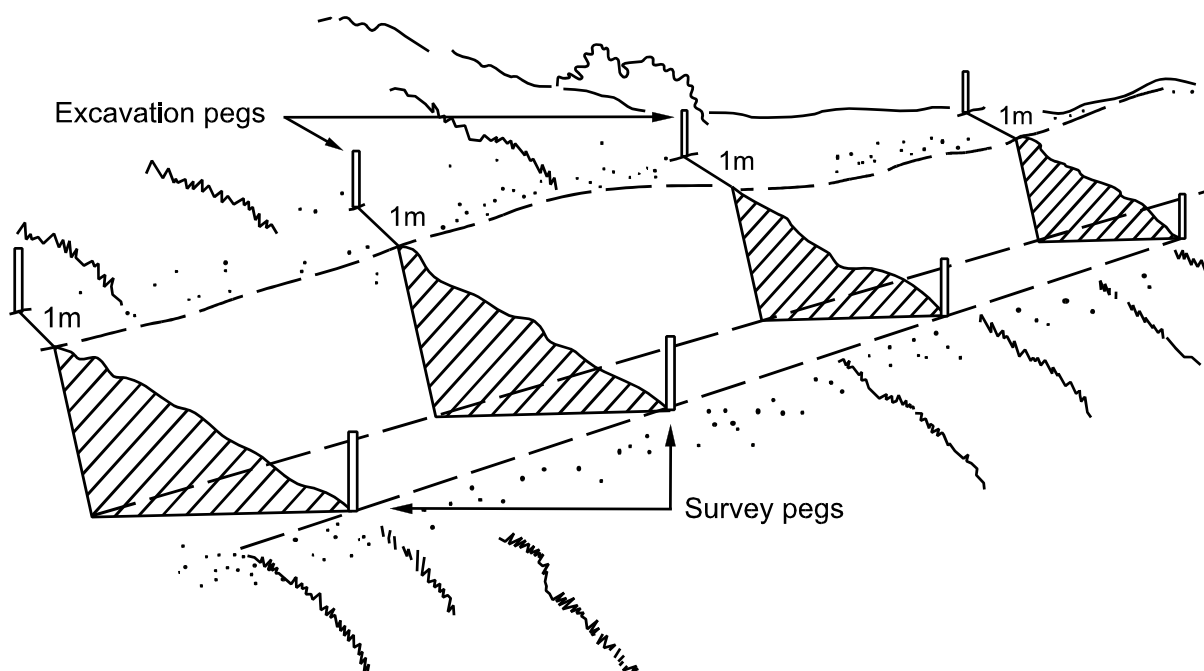

Where embankments have to be set out, the survey pegs should be marked to indicate how much will have to be dug or filled as shown below. When level measurements are written on the pegs, always measure from the top of the peg.

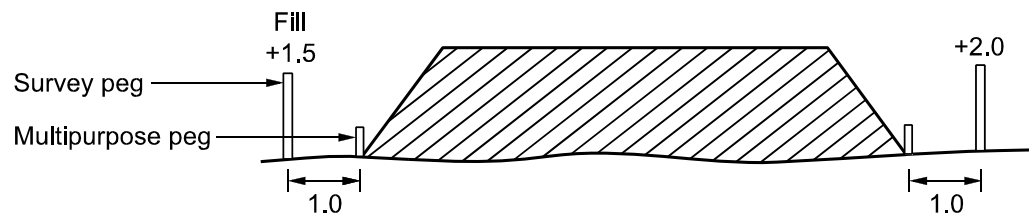

The pegs are set outside the areas of filling, not to be lost during the work (multi-purpose pegs can of course be put at the exact limits of excavation).

The width of cut or fill is determined by the formation width of the road and the angles of the side slopes of the excavation/embankment. Multi-purpose pegs should be set while the work goes on to show the workers where to dump or excavate the soil.



8.5 Setting Out Cross Sections

8.5.1 General Procedure

When a cross-section is set out in the field, survey pegs and multi-purpose pegs show:

- T the centre line of the road,
- T the level of the road (flat/hilly/mountainous terrain, cut, fill),
- T the location of the ditches,
- T the limit of excavation (cut, side long cut), and
- T the foot of the embankment (fill).

Normally, the road camber is set out together with the side drains. Once the position and levels of the centre line have been determined, it is possible to construct the camber and side drains. The cross section pegs should be set out at a right angle to the centre line pegs.

Setting Out the Road Camber

When setting out the road camber and side drains, it is important to reduce the amount of excavation to a minimum by following the existing level of the terrain along the road line. The procedure described below is an efficient way of setting out the road levels, achieving a well placed road with good drainage and which does not involve massive excavation and/or fill works.

Step 1: Using the previously set out centre line, set out ranging rods at 10m intervals along the centre line for a section of 50 to 100 metres. At the start of the section, measure out the position of the road shoulders and the outer end of the side drains from the centre line. Repeat this exercise at the other end of the section.

Place a wooden peg next to each of the ranging rods.

Step 2: Once the key positions of the road have been set out at the start and the end of the road section, sight in intermediate ranging rods at every 10m along the road shoulders and side drains.

Place wooden pegs next to each of the intermediate ranging rods.

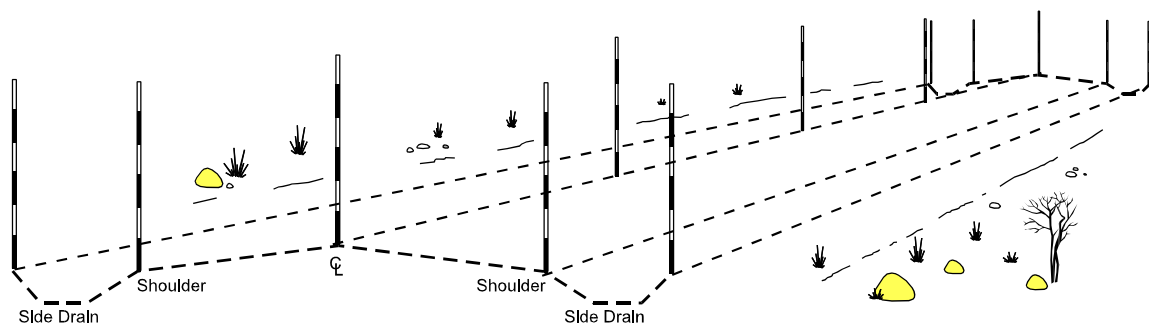

Step 3: On the centre line of the road, fix the first profile board. This profile may already be in position as the last profile from the previous set out section. If not, measure 1m up from the existing ground level, and mark this level on the ranging rod. Fix a profile board to the ranging rod so that the top edge of the profile board is at the mark made on the rod.

Step 4: Go to the centre line ranging rod at the other end of the road section and repeat the procedure, measuring up 1m from the ground level.

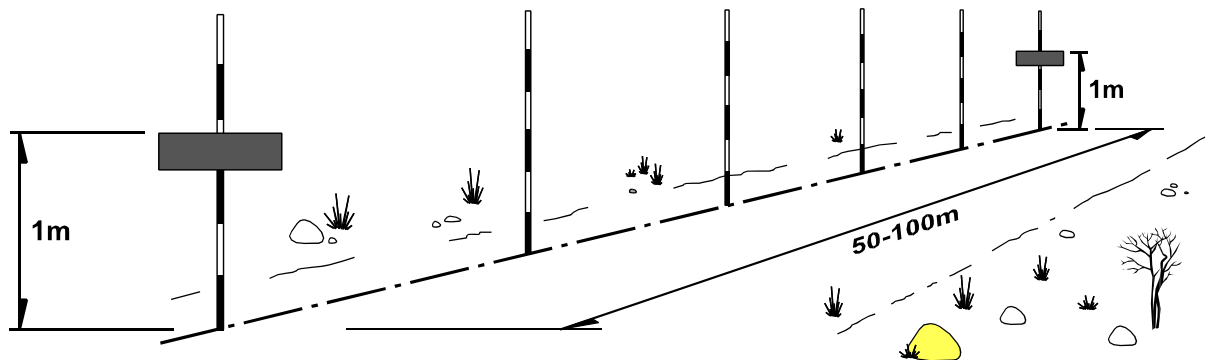

Step 5: By sighting in the intermediate profiles from one end, fix profile boards on the intermediate ranging rods along the centre line so that they are all at the same level.

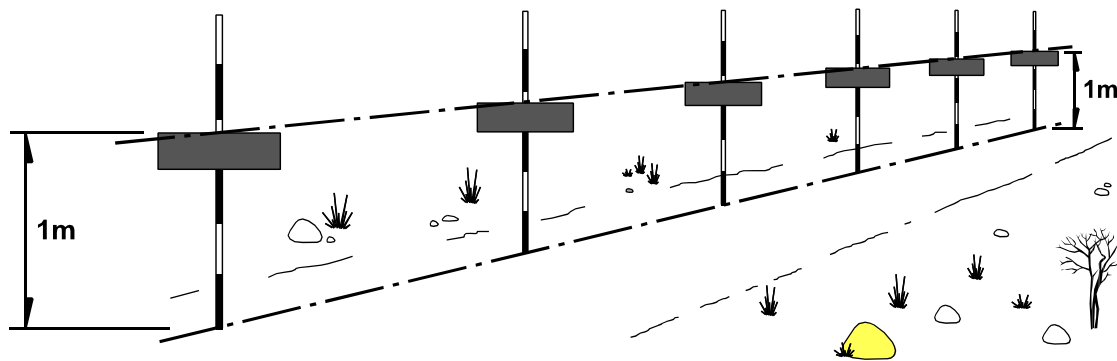

Step 6: Check the height of each profile board above the ground level. If the height is approximately 1m, there is no need to adjust them and you can use the level of the profile as it is.

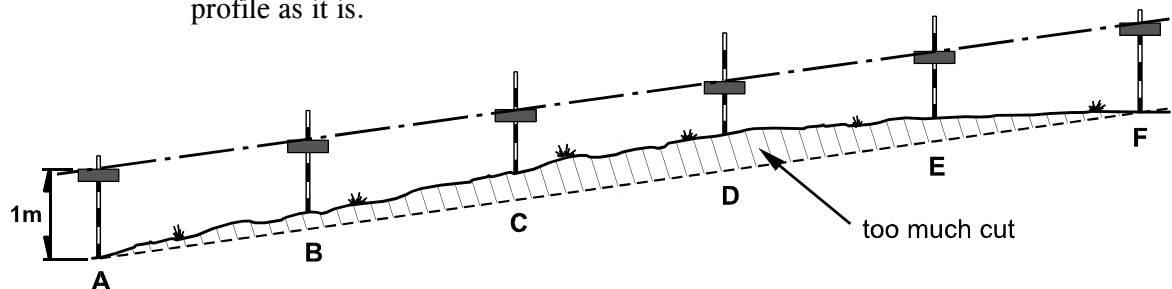

If the height of the profile boards is greater or less than 1m by 10cm, then inspect the line. There may be humps or depressions along the line. The set out line will in

most cases smooth out these variations. However, it may be that the set out line is over a hill or a dip in the terrain. In such cases, it is necessary to adjust the profiles to avoid too much excavation works.

Adjust the profile at position D so that it is 1m above the ground and then lift the profiles at B, C and E to sight in line with the profiles at A to D and D to F. This exercise will reduce the amount of excavation works.

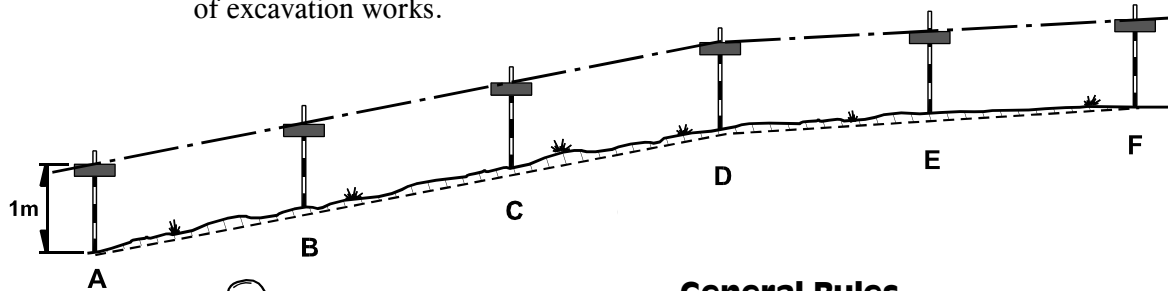

General Rules

1. It is better to lift profiles than to drop them.
2. Try to keep lifts and drops less than 10cm.
3. Try to match the road levels to the terrain.
4. Use the profiles to get a picture of the vertical road alignment.

Before starting on the next step, make sure that the side drains can be emptied. It is important to spend time on this step to get the levels right. All other levels will be set out based on the profiles along the centre line of the road.

Step 7: Transfer the levels to the ranging rods at the outer end of the side drains. Start with the beginning of the road section. Using a string and a line level, transfer the level of the profile board at the centre line to the ditches on both sides of the road. Once the levels are set out with profile boards, mark the levels on pegs next to each ranging rod.

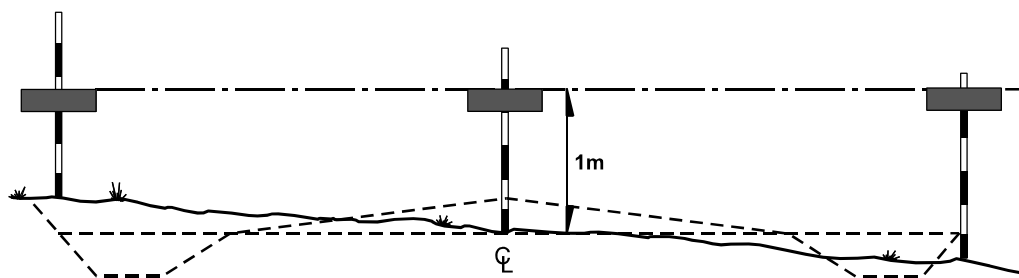

Repeat this procedure for the same two ranging rods at the other end of the road section and for any intermediate profile along the centre line that was lifted or lowered to reduce excavation works. Then, sight in the intermediate side drain levels.

In most cases, the height of the drain profile on the low side of the centre line is more than 1m. This is because we have started from higher grounds, and since the road is level, the lower side drains will be less deep.

Step 8: Mark the levels for the centre line on pegs placed next to the ranging rods along the centre line. Now, use the centre line profile boards to set out intermediate pegs, placed at every 5 m along the centre line. This is easily carried out with a 1 m traveller. Mark these pegs at the point where the bottom of the traveller touches the peg, when lined up with the profiles. On all the centre line pegs, mark the level of the crest of the camber.



Levels are usually written as three-digit numbers, showing the required cut or fill in metres (e.g. +0.20 means that a fill of 20 centimetres is required). When the level is indicated, always measure from the top of the peg.

You have now set out the profiles for the levelling of this road section.

Step 9: Place the levels of the shoulders along the road. For this, it is useful to have a traveller 1 m high. If we line up the traveller along the line between the two side drain profiles, the bottom of the traveller will show the correct level of the shoulder.

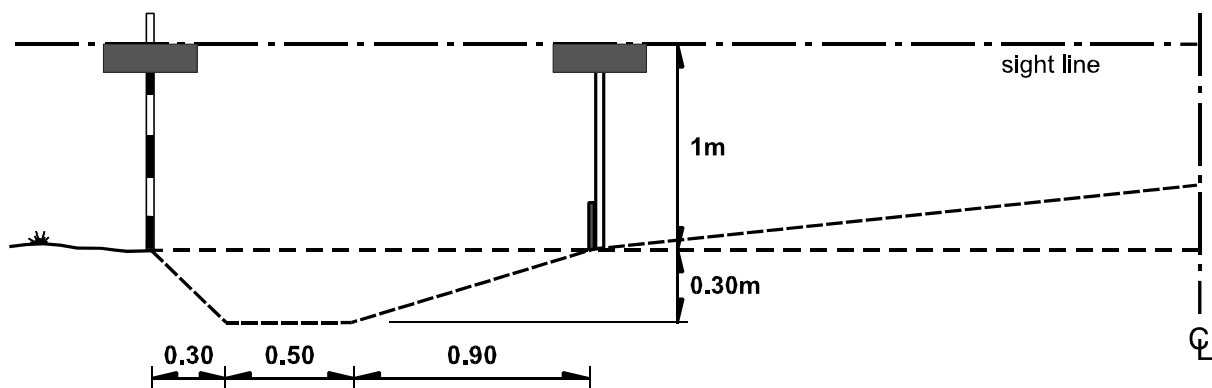

Place pegs every 5 m along the edge of the shoulder, and using the traveller, mark these pegs at the point where the bottom of the traveller ends when it lines up with the profiles.

Step 10: Locate and set out the mitre drains. It is important that the mitre drains are set out before the excavation works for the side drains and camber is commenced.

Step 11: Set out with string line the side drains that need to be excavated. Remember to leave out the mitre drain block-offs.

8.5.2 Cross-section of Standard Formation (flat terrain)

In this case, the survey pegs serve to mark the centre line as well as the road level. When it is necessary to cut or fill to reach the required level, this is shown on the peg.

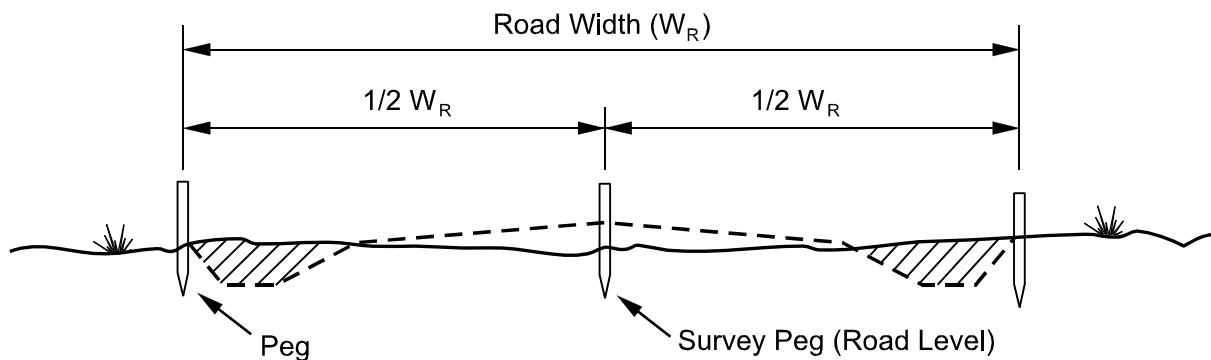

8.5.3 Cross-section of Side Cut

Here the survey peg marks the road level. After the road has been excavated to level, the centre line and ditch slope pegs will be placed.

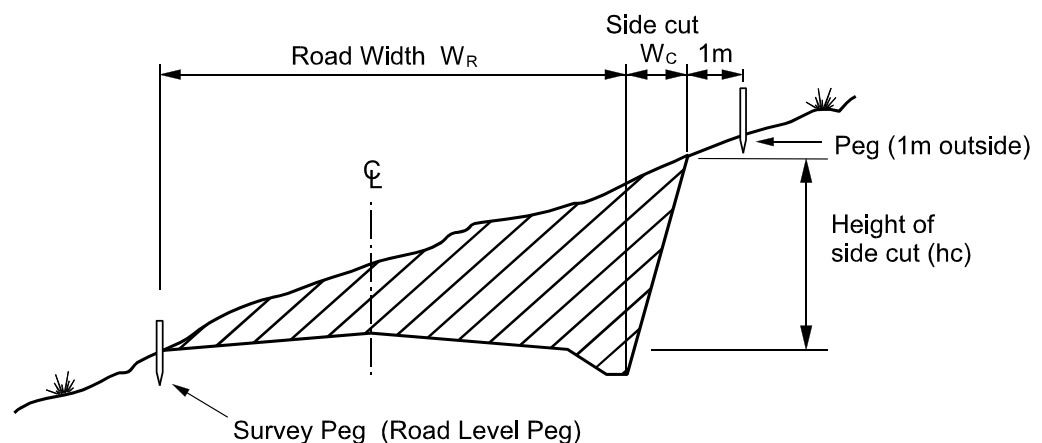

8.5.4 Cross-section of Cut to Fill

Again, the survey peg marks the future level of the road. The figure below shows that the volume of the excavation is approximately twice the volume of the fill and that a bench-notch should be dug to provide a stable foundation for the fill side of the road.

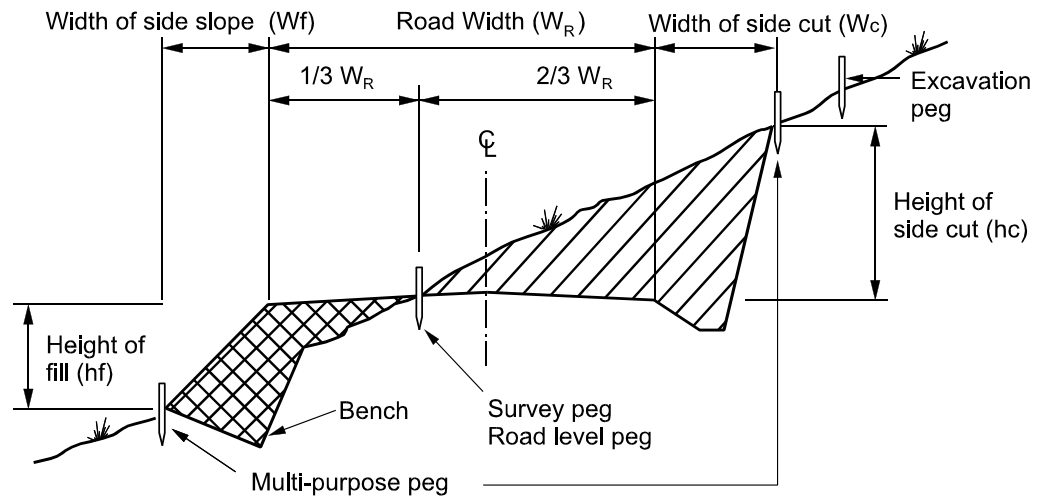

8.5.5 Cross-section of a Fill

The survey pegs on both sides of the road show the height to be filled. The height is marked on the peg and measured from the top of the peg. With a slope of 1:1 on both sides, the formation width can be calculated by adding h_{f1} and h_{f2} to the road width.

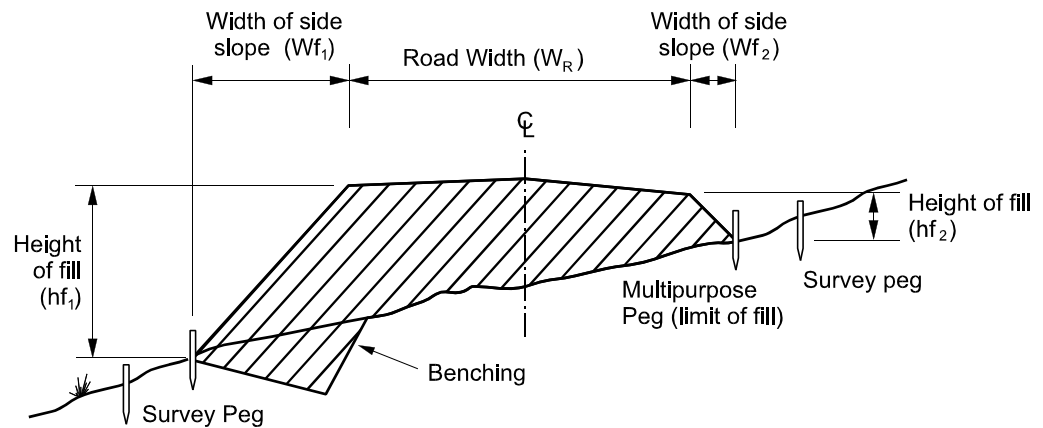

8.6 Hairpin Bends

8.6.1 Description and Function

In mountainous terrain where very steep slopes are encountered, it is sometimes unavoidable to use hairpin bends. These are bends with a very small radius continuing in some cases until the direction of the road has changed 180 degrees. When a number of hairpin bends are constructed, it is possible to descend a slope where little space for road construction is available. However, hairpin bends are not only difficult to construct and maintain but also difficult for traffic to use. Therefore, they should be avoided if alternative alignments can be found.

8.6.2 Setting Out Hairpin Bends

The figure below shows a longitudinal section of a hairpin bend. The bend joins two sloping road sections but the curve itself is nearly flat. This is necessary to provide a "rest" point to climbing or descending vehicles while they are negotiating the bend.

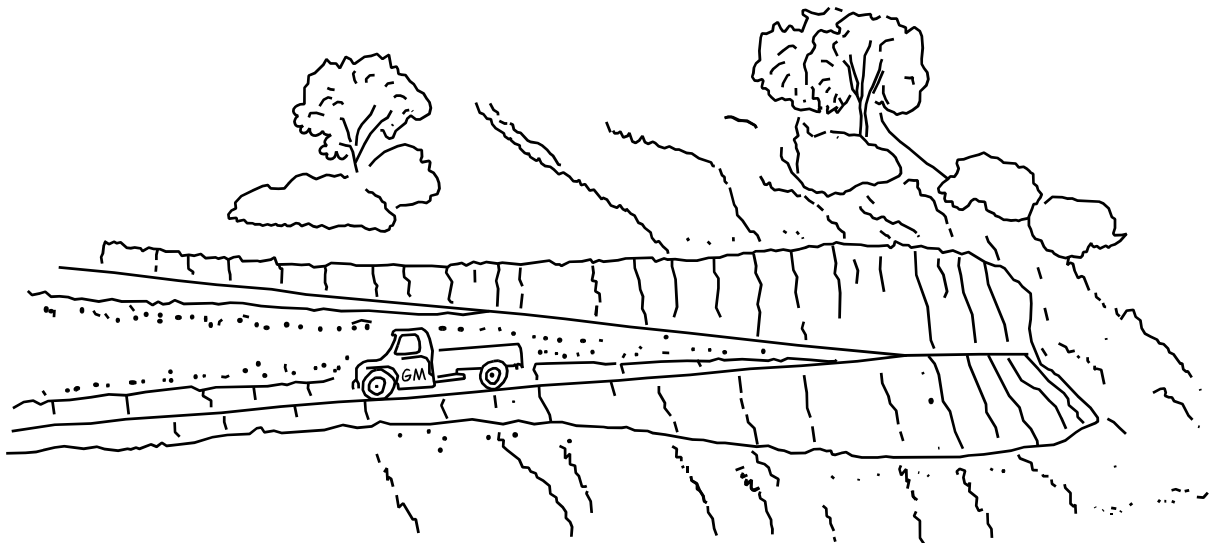

The following figure shows how the hairpin bend looks as viewed from above (plan). The survey pegs, which serve as road level pegs, are placed as shown on the plan during the initial survey of the road. Point "X" is the intersection point of the two level lines Z-X and Y-X. From this point the inner curve can be set out.

In the example used (radius of inner curve 3 m and road width 6 m), a cut of 12 metres will have to be made from Point X inwards. ($2 \times 3 \text{ m} + 6 \text{ m}$; see cross-section A-A). In the example, the radius of the outer curve is chosen to be 9.5 metres. However, to provide more space to the vehicles the centre of the inner and outer curve is not on the spot. The plan shows that the centre of the outer curve has been moved 2 metres inwards.

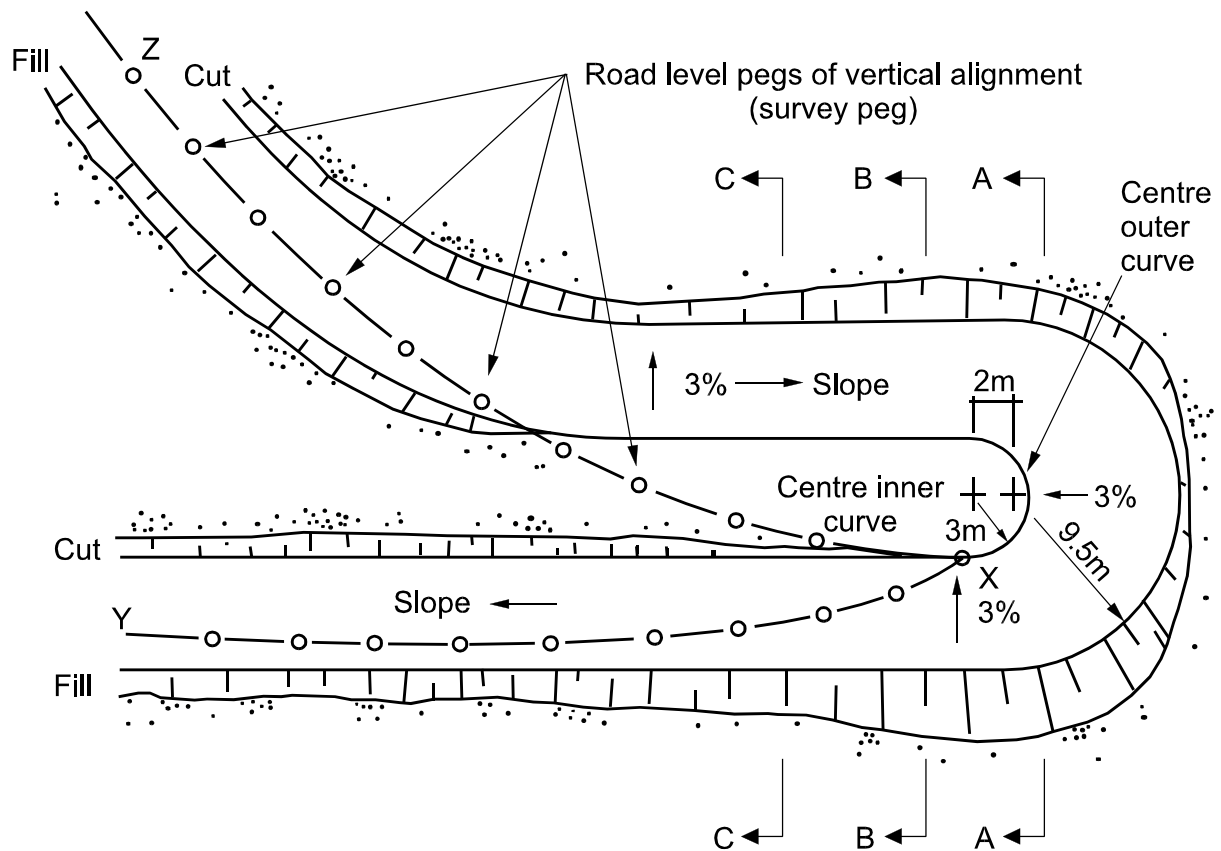

To provide good drainage and safety, the outer curve of the bend is set out to be higher than the inner curve. This means that the road will be sloping inwards, so that when the surface is slippery, vehicles will never slip towards the dangerous outer side of the curve. Also, all surface water will be collected at the inner side of the bend, so that erosion on the outside is minimized.

The figure on the following page shows the three cross-sections A-A, B-B, C-C which are indicated on the above plan.

These cross-sections can be set out after the road levels have been determined. Since hairpin bends normally occur in mountainous terrain, the normal camber is usually not applied, but the road is sloping towards the mountain to provide more safety and better drainage.

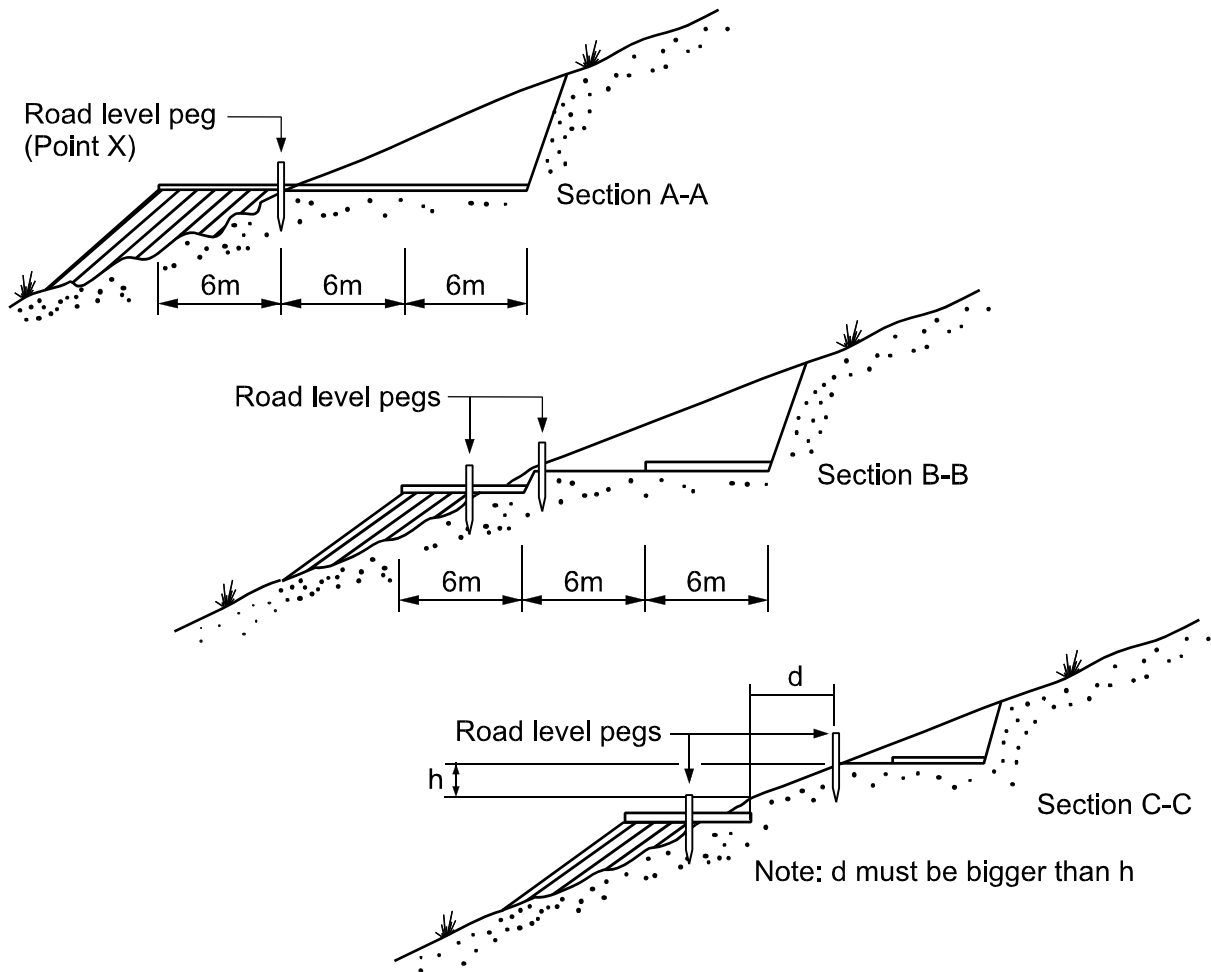

Cross Sections A-A, B-B & C-C through a hairpin bend

8.7 Setting Out Tasks

8.7.1 Importance of Setting Out Tasks

When using task work, it is necessary to set out the task clearly to show individual workers how much work constitutes the daily task. If the work is to be undertaken by pakyaw or contract, the work must also be set out to define the limits of the contract. The principal difference being that, for task work, the limits for individual workers have to be set daily but for contract or pakyaw only the limits of the contract are to be defined. Thus task work requires a greater involvement by supervisors.

8.7.2 Setting Out

Pegs and strings are normally used to set out lines or areas, not volumes. While it is therefore easy to stake out tasks for certain road construction activities, such as bush clearing and scrubbing, it is more difficult for other activities such as excavation to level, ditching and sloping. In the latter cases, you will have to use additional setting out aids (triangle set, boning rods, templates, or measuring sticks) to check the work after a certain area is covered.

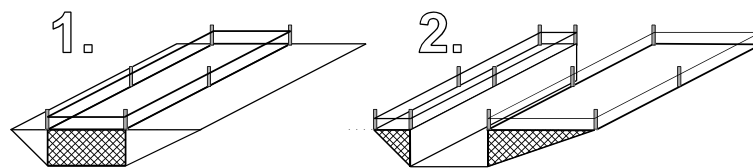

When for example, you have set out a certain length and width of a ditch to be excavated, you will have to check the depth with a measuring stick of a pre-determined length after the job has been completed.

You should accomplish this by using many multi-purpose pegs at close intervals or connecting the pegs with strings. This will clearly define and show what the workers have to do.

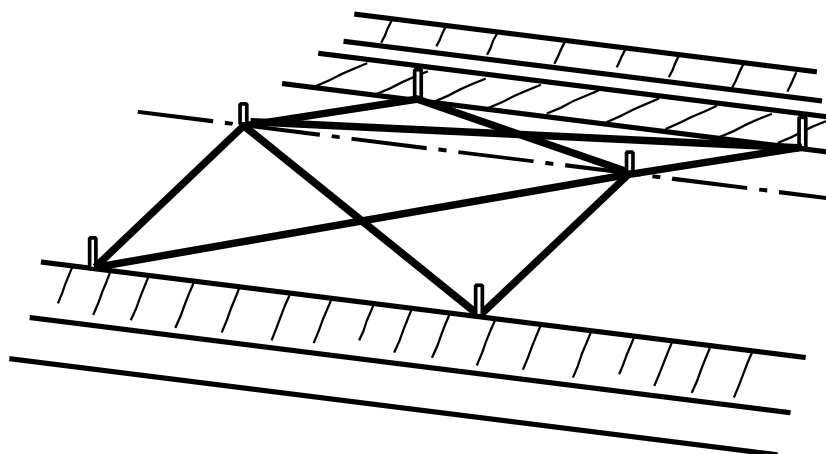

8.8 Recording the Work Programme

8.8.1 Calculation of Quantities

To establish quantities, the survey will be used to derive cross sections drawn to a reasonable scale (1/50 or 1/100), usually recorded at 20 or 25 metre intervals. Where conditions warrant it, the interval can be altered. In very flat and uniform terrain, the interval may be increased to say 100 m. Conversely, in steep or difficult terrain the interval should be reduced to 10 m or even 5 m.

For each survey station, the cross section should be drawn to enable the area of cut and fill to be derived. Also, different soil types may be recorded.

This format will record basic earthworks data of cut and fill between each control station. It is also a guide to the location of surplus cut and/or fill and indicates haul distances between adjacent cut and fill sections. A study of this format will reveal if cut and fill are reasonably balanced over sections of the project and whether or not the alignment may have to be revised in order to achieve a better balance of earthworks.

The use of efficient survey techniques and preparation of quantities will enable the project to be well planned and executed and provide data for use of the offices concerned regarding costs and productivity. Of immediate importance is that cut and fill volumes are separately recorded as these are separate activities requiring different inputs in terms of manpower and tools and therefore costing different amounts.

In summary, it cannot be over-stressed that a disciplined survey technique is absolutely essential to the successful execution of the work. In large capital-intensive projects, works need to be measured and calculated and bills of quantities prepared. Labour-based works are no different except that these works require simpler techniques that can be understood, appreciated and applied by project staff without the need for a high degree of academic training or sophisticated equipment.